



# FAI Sporting Code

*Fédération  
Aéronautique  
Internationale*

---

## **World and Continental Helicopter Championships**

### **Rules and Regulations 2015 EDITION**

Approved by the FAI Rotorcraft Commission ( CIG )  
on 06.March 2015

*Maison du Sport International  
Av. de Rhodanie 54  
CH-1007 Lausanne  
Switzerland  
Tél. +41 (0)21 345 10 70  
Fax +41 (0)21 345 10 77  
E-mail: [info@fai.org](mailto:info@fai.org)  
Web: [www.fai.org](http://www.fai.org)*

**FEDERATION AERONAUTIQUE INTERNATIONALE**  
**MSI - Avenue de Rhodanie 54 – CH-1007 Lausanne – Switzerland**

---

Copyright 2015

All rights reserved. Copyright in this document is owned by the Fédération Aéronautique Internationale (FAI). Any person acting on behalf of the FAI or one of its Members is hereby authorised to copy, print, and distribute this document, subject to the following conditions:

- 1. The document may be used for information only and may not be exploited for commercial purposes.**
- 2. Any copy of this document or portion thereof must include this copyright notice.**
- 3. Regulations applicable to air law, air traffic and control in the respective countries are reserved in any event. They must be observed and, where applicable, take precedence over any sport regulations**

Note that any product, process or technology described in the document may be the subject of other Intellectual Property rights reserved by the Fédération Aéronautique Internationale or other entities and is not licensed hereunder.

## **TABLE OF CONTENTS**

Chapter 1 – **BIDDING**

Chapter 2 – **GENERAL RULES AND REGULATIONS**

Chapter 3 – **ORGANISATION AND VENUE RULES**

Chapter 4 – **CRITERIA AND APPROVAL OF JUDGES**

Chapter 5 – **EVENTS**

- 5.1 Event 1 - Navigation
- 5.2 Event 2 - Parallel Precision
- 5.3 Events 3 – Parallel Fender Rigging
- 5.4 Event 4 - Parallel Slalom
- 5.5 Freestyle

Chapter 6 – **ADDITIONAL EVENTS.**

- 6.1 World Air Games
- 6.2 Internet Competition

Chapter 7 – **LIST OF TROPHIES AND AWARDS**

## **ANNEXES**

- A. Helicopter types and competition speeds
- B. Measuring Equipment
- C. Judges' qualification declaration

# World and Continental Helicopter Championships

## Chapter 1

### BIDDING

(to be read in conjunction with the General Section of the Sporting Code)

#### 1.0 AIMS

- 1.1 To determine a World or Continental Champion team, a World or Continental Champion crew and event Champions.
- 1.2 Popularisation of helicopter sports.
- 1.3 To improve pilot's flying skill.
- 1.4 To improve aeronautical relationship between participating countries.

#### 2.0 ORGANISER

- 2.1 The World or Continental Helicopter Championships are organized by NAC's under the control of FAI - CIG and in full accordance with the FAI Sporting Code and Regulations.
- 2.2 The NAC may delegate to another Organisation in its country part of its sporting power, but this does not detract from the NAC's responsibility to the FAI.

#### 3.0 OFFER

- 3.1 A bid to host a World or Continental Championship must be submitted for consideration by a CIG Plenary Meeting no less than 2 years before the proposed date.
- 3.2 A draft bid must be submitted to the CIG Bureau at least 3 months before the Plenary Meeting.

#### 4.0 DETAILS

- 4.1 A bid must include:
  - Identity of the Organizer and Organisations involved
  - Prospective dates for the Championship
  - The site of the proposed Championship
  - Detailed maps of the Competition Area
  - Average local weather conditions of the site
  - Airspace restrictions
  - Characteristics of the location
  - Insurance requirements
  - An indication of the entry fee and what it includes
  - Hotel and catering information
  - Statement that all NAC's will be invited. This means that invitations, in writing, will be sent to all NAC's in the first instance

- Advice on the possibilities of hiring helicopters and any national licensing requirements
- Travel advice

## **5.0. FAI-CIG ORGANIZER AGREEMENT**

- 5.1. Each bid must be accompanied by a signed Organizer Agreement. A bid without a signed Organizer Agreement will not be considered. Bids made by an unsuccessful bidder will be immediately returned.
- 5.2. In the event of the acceptance of a bid FAI and CIG will immediately sign the Agreement. Copies will be held by FAI, CIG and the successful NAC.
- 5.3. CIG may delegate full powers to its Bureau to clarify any 'agreed' provisional matters.

## **6.0. OFFICIALS**

- 6.1. A successful bidder, at the time of acceptance, may propose the officials to be approved by CIG. There may be substitutions at a later date.

# World and Continental Helicopter Championships

## Chapter 2

### General Rules and Regulations

(to be read in conjunction with the General Section of the Sporting Code)

#### 1.0. PARTICIPANTS

- 1.1. Teams and individual crews, Members of National Aero Clubs affiliated to the FAI may take part in the World or Continental Championships. The delegation of each country may include: Chief Delegate, Team Manager, FAI Judges and Assistant Judges, Pilots and Crew Members, Mechanics, Interpreter and additional personnel announced by an entry form. A participant may only act in a single capacity (except Chief Delegate and Team Manager which may be combined in one person). There shall be a maximum of 10 judges (including Assistant Judges) per country.
- 1.2. Each country may enter a maximum of 7 crews. Each crew may compete for the individual title of "Helicopter World or Continental Champion". A crew can be all-male, all-female or male and female. A crew consists of 2 persons. A National Delegation may include an un-limited number of pilots to compete in Event No. 5.5 (Free Style) only. This event will be flown solo by the pilot.
- 1.3. An additional 3 crews over those in 1.2 may be included in the national delegation from the organizing country to compete for the individual title.
- 1.4. Up to 3 "all- female crews" may also be entered in addition to those mentioned in 1.2 and 1.3 above. If there are more than 3 countries participating with all-female crews, an individual World or Continental Female Title will be awarded.
- 1.5. Each national team will be composed of a minimum of 3 and a maximum of 5 crews. Team crews must be declared and published not later than 12 hours before the competition starts. Their results will count for both the country team result and individual result.
- 1.6. The defending Overall Champions and the defending Female Champions from the immediate previous championship have the right to defend their title. They are regarded as extra crews over and above the numbers set out in 1.2 – 1.4.
- 1.7. Each crew member must be in possession of a valid FAI Sporting Licence, issued by the National Aero Club in which they are registered as a member and are citizens or residents of NAC's country.  
A crew whose members represent different NACs may be accepted by CIG as an International crew. There must be no changes of crews/countries within 3 years.
- 1.8. A National Aero Club being unable to enter a team of 3 crews, required for team classification, may enter individual crews.

- 1.9. Crews must participate in all Championship events 1 – 4 inclusive. Participation means having passed the departure line.
- 1.10. The Championship Director may permit a change of a crew member in a National Team. No change is permitted later than 6 hours before the first event flight, and the change must be published. In case of a mechanical breakdown in a helicopter before the competition or before an event, the Championship Director may permit the competitor to fly another helicopter.

## **2.0. TYPES OF HELICOPTER, LICENCE AND DOCUMENTATION**

- 2.1. Helicopters of any type with sufficient characteristics to execute World or Continental Helicopter Championship events will be allowed to compete in the Championship. If there is any doubt, the flight manual will be used as reference.
- 2.2. A valid “Certificate of Airworthiness“ or equivalent document and a Certificate of Registration issued by an appropriate Authority must be produced to the Organizer for every competing helicopter.
- 2.3. Pilots must be in the possession of a valid Pilots Licence complete with Medical Certificate.

## **3.0. INSURANCE**

- 3.1. It is compulsory for each competing helicopter to have third party insurance policy for an amount of a minimum of 2,000,000 Swiss Francs (or equivalent), for the whole duration of the Championship and for the flights over foreign territory to the competition site. Personal insurance of pilots and insurance of helicopters will also be covered by their nation. All members of a national delegation must carry individual health insurance. Copies of insurance policies with confirmation in English of validity must be submitted by each competitor.
- 3.2. Country Regulatory Authorities may have compulsory higher limits. Therefore, the minimum cover specified in Rule 3.1 will be increased to meet government requirements but in no case be lower than stated in Rule 3.1. above.

## **4.0. ENTRIES AND FEES**

- 4.1. An entry will be accepted if made on an official entry form and received by the specified closing date. Late entries may be accepted at the discretion of the Organizer only when there is a good reason.
- 4.2. The official entry form can be submitted to the Organizer through postal services, e- mail or fax.
- 4.3. The amount of the entry fee will be calculated by the Organizer and approved by FAI-CIG. The entry fee covers the costs for accommodation in twin rooms and

food plus organized events and transportation throughout the duration of the Championship for all delegation members. There shall be a higher amount for competing crews.

- 4.4. The entry fee will be paid 2 months before the Competition.
- 4.5. All Entry fees will be refunded if the World or Continental Helicopter Championship does not take place.
- 4.6. If any delegation arrives at the Championship with incomplete or missing documentation the entry fee will not be refunded.
- 4.7. The entry fee does not include personal expenses.
- 4.8. The Organizer will announce to all participating NACs in a preliminary bulletin the following details:
  - Amount of the entry fee for crews, delegation members, judges and additional personnel
  - Extra fee for single rooms
  - Bank account for payment of entry fees
  - Dates and Agenda of the Championship
  - Details concerning Check-in, Initial briefings and the proposed programme.
- 4.9. The Organizer will pay the Sanction Fee to the FAI-CIG account, being a sum equal to 100 Swiss Francs per delegation member, excluding judges. The payment is to be received by FAI not less than 30 days prior the start of the Championship.
- 4.10. Any outstanding fees owed for late entrants must be paid to the FAI - CIG President or the President of the Jury prior to the commencement of the Championship. Any overpayment of Sanction Fees will be refunded to the Organizer within 30 days of the end of the Championship and the publication of the results.
- 4.11. In the event of non payment or dispute the CIG President, together with the International Jury will decide on an interim payment to be made prior to the commencement of the Championship. The FAI - CIG will ratify this at the next Plenary Meeting. The Championship will not commence until this payment has been made.

## 5.0. PROGRAMME OF EVENTS

- 5.1. Competitors will be required to perform the following:
  - Event 1: Navigation
  - Event 2: Parallel Precision
  - Event 3: Parallel Fender Rigging
  - Event 4: Parallel Slalom

Event 5 is optional. It will not count towards the overall Championship.



- 5.2. The sequence of the Championship events will be announced during the initial briefing.
- 5.3. The sequence of flights will be given by the Championship Director the previous day and confirmed at the daily briefing. The sequence will have been determined taking into account the following factors:
  - Speeds of consecutive helicopters to avoid overtaking and bunching in Event No1.
  - Maximisation of time spacing for shared helicopters in Event No.1.
  - Avoidence of unnecessary weight changing for a shared helicopter in Event No.2
  - Avoidence of the same running order for consecutive Events.

## 6.0. FLIGHT SAFETY

- 6.1. The Organizer will appoint a 'Safety Officer'. He will assist the Championship Director to observe and guarantee the safety of the flights on the competition site.
- 6.2. The Safety Officer must, in addition to any National recommendations, be provided with a copy of the FAI's Recommendations.
- 6.3. During the competition all competitors must observe and adhere to the rules of the air and special regulations in force in the Host country. The Organizer must supply to the participating delegations all relevant regulations, documents und NOTAMS in force concerning the competition flight area. Any violation of flying or safety regulations in force may lead to the exclusion of the offender from the contest. No responsibility can be undertaken by the Organizer for any violation of air safety by competitors or others.
- 6.4. A competitor taking drugs, alcohol, medication or suffering from any illness or injury which might invalidate his licence or insurance, or in any way affect his performance, must inform the Championship Director before flying. All competitors shall accept that they may be required to submit to, and co-operate with, doping control measures.
- 6.5. All personnel participating in the competition area during events must be clearly marked. All safety measures will be taken to prevent any dangerous situation in the vicinity of helicopters and to prevent foreign object damage either to helicopters or personnel.
- 6.6. Team managers and all other non-judging personnel will not be allowed into the competition area during events. Media personnel and VIP - visitors are only allowed into the competition area during events if they are at all times strictly supervised by Organizers personnel and remain in marked areas approved by the Chief Judge.

- 6.7. Due to weather conditions or for safety reasons, the President of the Jury and / or the Chief Judge can vary the length of the course and the dimensions of the search box.
- 6.8. Mandatory Fly Over ( MFO ) points are to be used to provide required routing and separation at the discretion of the Organizer.  
MFO points are to be clearly recognizable on the ground and the position to be explained to the crews prior to the commencement of the Championship.

## 7.0. WORLD OR CONTINENTAL CHAMPIONSHIP BODIES

7.1 The Management of the competition consists of:

- The Championship Director
- The Jury
- The Chief Judge
- The Deputy Chief Judge

7.2 The Championship Director is appointed by the Organizer and approved by the FAI - CIG. He bears full responsibility for the Organisation of the contest and the smooth operation, timing and safety of the flights on the competition site.

- Before the start of the contest he will advise the team managers of the national delegations, the crews not having team managers, the members of International Jury and the Chief Judge, on the flight conditions within the Championship programme, as well as other problems which could arise from the interpretation of the General Rules.
- In accordance with the General Section of the Sporting Code Chapter 5 the Championship Director may disqualify a competitor for the reasons stated below:
  - Unsafe flying and violation of airspace
  - Refusal to abide by a decision made by the technical advisers
  - Repeated serious infringement of competition rules
  - Use of forbidden equipment, alcohol or drugs.
  - Cheating or repeated unsporting behaviour (Abuse of officials, insult of participants verbal or with gesture, attempt to influence decisions of judges ).

In cases of disqualification the entry fee is not returnable. The FAI Sporting Licence should be withdrawn and returned to the Competitor's National Aero Club with a report.

7.3 The International Jury is responsible for dealing with protests. It monitors the Championship in accordance with the Sporting Code, General Section and will intervene if the FAI Rules are not respected.

The International Jury is nominated by the FAI - CIG and composed of a President and 2 members who must represent different countries and be all members of CIG.

The President of the Jury has the power to stop the event if the Organizer fails to abide the published Rules and Regulations for the event until a Jury meeting has considered the situation.

No Jury Member is allowed to be connected in any way with their national team or crews or participate in any way in the running of their national team during the competition.

All members of the International Jury shall be present at the Championship location during competition flying. The President of the Jury will make his whereabouts known so that he may receive protests during the appropriate period. In case of a protest the Jury will meet as soon as possible but may defer their deliberations to more convenient time during the Championship.

The Jury members travel expenses and entry fees, including the official practice event are to be borne by the Host NAC.

- 7.4 The Chief Judge and Deputy Chief Judge are nominated by FAI - CIG. Either the Chief Judge or the Deputy Chief Judge must be present in the competition area at all times during competition flying. They have the responsibility to organize the work to be carried out by the International Judges and Assistant Judges and to report results to the Championship Director. They are also responsible for dealing with complaints concerning rules or judging matters and advise the Championship Director, team leaders and crews on interpretation of the Rules and Regulations and on penalties. The Chief Judge is also responsible for producing the variable parts of event 2 ( choice of turning points ), event 3 ( direction of flight through of entrance gates ) and event 4 ( flight through directions and exact position of gates 5 and 6 ) before registration day. The Chief Judge's and Deputy Chief Judge's entry fees and reasonable travel costs, including the official practice event are to be borne by the Organizer.
- 7.5 A Technical Adviser Team will be composed of 3 to 5 engineers and mechanics appointed by the Organizer. This team is responsible to the Championship Director for the inspection of the required documents and the helicopters. The Technical Adviser Team will inspect all helicopters and will seal the instruments which could assist the pilot to fly the helicopter and provide an unfair advantage over other competitors. A competitor removing any seal will be disqualified from the Championship.
- 7.6 The Safety Officer will be present at all times during the competition events. For events 2 to 5 inclusive he will be present in the competition area. In the event of actual dangerous incident he must immediately inform the Chief Judge, or the Championship Director or the Jury.
- 7.7 The President of the Jury or a designated member of the Jury and the Chief Judge or the Deputy Chief Judge must be at the competition site at least three days

before the start of the competition to ensure that the Organizer has complied with the rules and details of the competition.

- 7.8 The International Jury, the Championship Director or Judges may not change any rule or penalties approved by CIG.

## **8.0 JUDGING**

- 8.1 Judging during the World or Continental Championship will be carried out by an International Board of Judges, the members of which must meet the standards laid down in Chapter 4 and be approved by FAI - CIG.
- 8.2 All participating NAC's have right to be represented on the Board of Judges by FAI International Judges approved by CIG.
- 8.3 The Board of Judges will be composed of:
- A Chief Judge
  - Deputy Chief Judge
  - International Judges
  - Assistant Judges
- 8.4 Assistant Judges are nominated by each participating NAC and must have been registered with CIG before the Championship starts. An Assistant Judge may perform all tasks not involving subjective judgment. Tasks include timing, scoring boundary line violations, and duties associated with preparation and departure lines and other tasks assigned by the Chief Judge or the Deputy Chief Judge consistent with basic restriction. Experience as an Assistant Judge at National and International Championships shall be considered by the National Aero Club when determining upgrading to International Judge status.
- 8.5 Under exceptional circumstances during the contest, the Chief Judge may allow a change in the Board of Judges.
- 8.6 The Judges and Assistant Judges will be placed by the Chief Judge or Deputy Chief Judge at appropriate places for observing and evaluating competition flights, including places that require the use of technical equipment, as determined by the Judge Allocation and briefing notes. No more than 3 FAI Judges and/or Assistant Judges are permitted at any one judging point and will have a common language for purposes of communication.
- 8.7 The scoring sheets of Judges may be collected intermittently during an event. Immediately after completion of an event and its marking by Judges, the score sheets must be given to the Chief Judge or the Deputy Chief Judge.
- 8.8 If a Judge becomes aware of a breach of FAI Regulations or Championship Rules and is in possession of detailed evidence or he /she disagrees with the judgement of other judges on his judging point, he must make his appropriate remarks on the scoring sheet and bring this to the attention of the Chief Judge or Deputy Chief Judge immediately.

- 8.9 If an FAI Judge notices a mistake in the preliminary results for his judging point, the error should be drawn immediately to the attention of the Chief Judge. The Chief Judge will clarify the matter together with the Championship Director and scoring personnel. The Chief Judge will inform the Judge about the findings.
- 8.10 The deliberations of the Board of Judges and the International Jury are confidential. They must not be discussed with Delegation or crew members. During his duty as a FAI official no judge is allowed to maintain close connection with crews or members of Delegations.
- 8.11 The Chief Judge may suspend a Judge in the case of failure to carry out his/her duties. A report will be forwarded to his/ her NAC.
- 8.12 Prior to the start of the Championships, the Chief Judge will undertake a briefing conference which is compulsory for all Judges and Assistant Judges to attend. This conference will take place the day before the first flying event of the Championship at a time decided by the Chief Judge.
- 8.13 No Judge may raise questions of rules interpretation at briefings where participating crews are present.

## **9.0 DETERMINATION OF WORLD OR CONTINENTAL CHAMPIONS**

- 9.1 The “ Team World Champions “ will be the best 3 crews of a country team, having the highest number of points compared to all other groups of 3 crews from each other country.
- 9.2 The “Overall World Champions“ will be the crew having the highest score of all other crews.  
The “Female Champions” will be the all-female crew having the highest score of all other female crews.
- 9.3 Event Champions in Events ( 1 to 5 ) are determined by the highest number of points obtained in each of these events.
- 9.4 The pilot with the highest overall score where this pilot has less than 250 hours total time, will be nominated “ Best Novice Pilot “.
- 9.5 Medals and Diplomas must be purchased by the Organizer from FAI.

## **10.0 COMPLAINT AND PROTEST**

- 10.1 The purpose of a complaint is to obtain a correction without the need to make a protest.

- 10.2 A competitor or a team who is dissatisfied on any matter during the Championship should first ask the appropriate official for assistance. If still dissatisfied, a complaint in written form should be made by the competitor or through the team manager to the Championship Director or his designated official, without delay. All judging matters will be passed by the Championship Director to the Chief Judge for determination.  
If dissatisfied with the decision on a complaint, a competitor or team manager has the right of protest.
- 10.3 There will be a time limit of 1 hour from the time the preliminary results are officially published and the time entered on the result sheets during which a complaint may be lodged. Once the Championship Director or the Chief Judge has reached a determination of the complaint and communicated it to the relevant competitor or team manager, there will be again a time limit of 2 hours in which a protest may be lodged.  
Protests are accepted from a competitor via his team manager or from the respective team manager. If a competitor has no separate team manager, he may lodge the protest himself. Protests are only possible against an issue which affects the competitor himself. All protests will be written in English and forwarded together with the deposit of 600,- Swiss Francs ( or equivalent ) to the Championship Director, who will in turn pass it to the International Jury. The deposit is reimbursed if the protest is upheld. The Jury may order a protest fee to be reimbursed in total or in part even though the protest is denied.
- 10.4 Where one issue affects several crews of the same delegation they may all submit the same protest for one fee of 600,- Swiss Francs. However, the deposit is reimbursed only if the protest is upheld for all crews submitting the protest.
- 10.5 The International Jury must allow the protesting competitor and/or the team manager to give evidence.
- 10.6 No complaint or protest will be allowed regarding the method, accuracy, or use of measuring equipment which has been approved as per 12.6. Judgements made without the use of approved equipment, or where no equipment is used at all, are not subject to this restriction.
- 10.7 If a Team Manager becomes aware of a serious breach of FAI Regulations or Championship Rules and is in possession of detailed evidence he must bring it to the attention of the Chief Judge and the Championship Director. He must produce all the detailed evidence to support his allegation without which the allegation will be rejected. If an allegation is found to be unsubstantiated or mischievous FAI and the NAC will be informed.

## 12.0 OPERATIONAL REGULATIONS

- 12.1 Competition flights are performed under the following weather conditions:
- Event 1 and 5: Minimum cloud height of 300 metres and minimum horizontal visibility 2 kilometres or the minimum legal flying conditions of the host country whichever is the greater.
  - Event 2, 3 and 4: maximum wind speed of 15 knots unless all team managers unanimously agree otherwise at the event briefing.
  - Event 5 maximum wind speed of 8 knots.
- 12.2 A common VHF frequency will be provided to all competitors. All other frequencies will be sealed off. However, in the event of an emergency, the seal may be broken to facilitate radio transmissions.
- 12.3 All pilots will be briefed on Flying Rules in the Competition area for any away flight conducted outside the official contest programme. All pilots must be acquainted with the area where the flights are allowed. Transit maps of the region will be distributed to all pilots at the first briefing.
- 12.4 The Competition maps approved by CIG (at its meeting prior to the Championship), will be supplied to each NAC in sufficient quantity for each competing crew 4 weeks before the Championship together with the field sketches indicating parking, refueling and the location of Events 2, 3, 4, 5. A list of competitor numbers will be preallocated to each country. The Competition map should have a scale of between 1:200.000 to 1:250.000 and normally used in Organizer's country as an aeronautical map.
- 12.5 Only designated pilots will fly during competition except in the case of an emergency. The crew member / co-pilot is restricted from handling the flying controls during events and infringement will result in disqualification.
- 12.6 The details of all measuring equipment to be used during Championship are to be submitted to the FAI - CIG for consideration. It is the Organizers responsibility to ensure that the equipment or its technical description, user instruction or user handbooks and certification of worthiness is available at the annual CIG meeting prior to the Championship. Stopwatches are exempt from this requirement but methods for determining Start / Finish and measuring distance are not unless previously approved.
- 12.7 The method of measurement of the data listed in Annex B must also be submitted to the FAI - CIG for consideration as per 12.6.
- 12.8 To ensure good media coverage, competing aircraft may be required to carry a television or film camera. These will be mounted in a manner compatible with airworthiness requirements at the discretion of the Championship Director.

- 12.9 Helicopter Types will be given a competition speed based on 80 % of the maximum safe sustainable cruise speed in straight and level flight with two average weight persons and 1,5 hours fuel on board. The maximum competition speed shall not exceed 90 knots. The FAI - CIG will determine speeds for all currently operating helicopter types after consultation with experts on each type and maintain a list. The list will be maintained in Annex A of these rules and may vary from time to time.
- 12.10 Standard fuel sufficient for the Championship tasks ( AVGAS 100 LL and JET A1 ) will be provided by the Organizer. The Organizer will not supply oil or lubricants. Wherever non-standard fuel has to be used, their supply will be the participant's responsibility. Fuel, oil or lubricants are not covered by the entry fee.
- 12.11 How many crews may share one helicopter in any event depends on organisational circumstances and the Championship Director's decision.

### **13.0 COMPETITION RULES**

- 13.1 It is the responsibility of crews to ensure their proper understanding of the Competition and Events Rules.
- 13.2 Any change in the schedule due to weather etc. will be posted on the information board and announced at briefing.
- 13.3 Crews will be given "lift off" times for each event and it will be their responsibility to be ready at the preparation line. The Championship Director may announce changes to lift off times just prior to or during an event.
- 13.4 Late arrival at Line P will normally be penalized by 5 points for each minute of delay or part thereof to a maximum of 25 points. After 5 minutes delay the competitor will be required to fly last. In the event of a proven technical problem, the Championship Director may authorize a change in departure time.
- 13.5 If a competitor interrupts his flight after crossing the departure line for any technical reason including low fuel during the event, he will not be allowed to repeat it.
- 13.6 Except where another penalty is specifically provided for, the penalty for infringement of any rule is 10 points.
- 13.7 Use of special equipment, such as auto stabilizing equipment, auto pilot and certain radio aids is not permitted, unless it is listed in the Operator Flight Manual as necessary to conduct normal safe flight. Radar and Radio Altimeters and GPS capable devices including mobil phones are not permitted for the 4 events of the competition. Any infringement will result in disqualification.



- 13.8 The Championship Director will choose at least 10 % of participating crews and helicopters for relevant inspections during the competition. All competitors shall agree to this examination including body search.
- 13.9 Practice is prohibited during the Championship and will incur a penalty of 50 points per occurrence. Competitors will be allowed to check the height of the weights during fitting in Event 2 and will be allowed a left and right turn on the “ P “ Line to check aircraft performance. Private flights may only take place with special permission from the Championship Director.
- 13.10 A contest number must be clearly visible on the left and right sides and under the front part of the helicopter during the whole Championships. The size of the numbers will be 30 by 30 cm, or as large a size as is reasonable possible and will be black numbers on a white or yellow background. Provision of the contest numbers is the responsibility of the Organizer. Numbers will be fixed by each crew before the first competition day. The Chief Judge or his delegated Official will confirm the compliance prior to the first event.
- 13.11 Each competing helicopter must comply with its own National Flight Regulations, and must be equipped with a VHF radio and normal standard equipment.
- 13.12 A black flag shown to a competitor means he is disqualified for the Event. “Black flags“ are explained in some score events and will be detailed during briefing. Black flags can only be shown by judges on the authority of the Chief Judge or the Deputy Chief Judge or by themselves.
- 13.13 All Judges and Assistant Judges will bring a stopwatch with them to the Championship.
- 13.14 All times are to be measured to an accuracy of at least one tenth of a second and to one hundredth of a second where possible. The personnel responsible for calculating and collating scores will round the scores to the nearest tenth of a second before allocating penalty points. Times from 0.01 to 0.04 of a second will be rounded down to the previous tenth of a second whereas times from 0.05 to 0.09 of a second will be rounded up to the next tenth of a second.
- 13.15 The required equipment for all events, specially described in the event rules and their annexes, will be provided by the Organizer. No other equipment should be used by the competitors.  
All equipment which will be used by crews during the respective events must be available for inspection at the event briefings.  
Any lines or markings for all events, fixed equipment such as the slalom course, the fender rigging course or the dog house, must be in place and available for inspection by competitors and officials at least one hour prior to the departure of the first competitor. A plan of how the course is to be laid out ( including free-style box ) should be given to the Jury President at least 24 hours prior to the first departure.

- 13.16 The preliminary results of each competitor for every event will be published not later than 3 hours after completion of flying. The scoring in detail will be published as soon as possible after each flight. The preliminary results of each event with the crew's placing will be published on the information board. The final results with the placing will be published not later than the next day following the task concerned. Team Managers have the responsibility of obtaining this information and informing their crews within the appropriate time period.

# World and Continental Helicopter Championships

## Chapter 3

### Organisation and Venue Rules

#### 1.0 GENERAL

Prior to any National Aero Club offering to host a World or Continental Helicopter Championship, the National Aero Club must be able to satisfy FAI –CIG on the following points:

- 1.1 Sufficient experience exists in the Host Country to ensure a high standard.
- 1.2 There should be at least 4 officials experienced in the discipline who are able to provide their knowledge and experience in respect to organizing Championships.
- 1.3 It is advantageous but not compulsory that the Host Aero Club combine with their National Military or Government in their offer to host an event. FAI – CIG would give consideration to 2 National Aero Clubs offering to jointly host a Championship on their National Borders subject to the respective Government approval.
- 1.4 The Host National Aero Club must provide an airfield with limited traffic. An airfield with bi-lingual controlling at any time during practice or the championship must be avoided.
- 1.5 The Host National Aero Club must satisfy FAI – CIG that a championship can be run with regard to the reasonable cost of participation by individuals.
- 1.6 In selecting a venue the Host National Aero Club must be able to provide acceptable reasonable accommodation close to the airfield with facilities for adequate parking and local championship transportation.
- 1.7 The Host National Aero Club must develop a close working relationship from the time that approval is given with both the President of the International Jury and the Championship Chief Judge.
- 1.8 The Host National Aero Club must comply with the following Rules and Regulations. If any doubts exist to their interpretation the advice of the President of the Jury should be sought at an early stage.
- 1.9 The Host Country must not run other local competitions at the same time unless they are under identical rules. Practice time on the airfield or in the navigation area is reserved for Championship Events with spare time only for any local event practice.
- 1.10 Practice for display, demonstrations, etc. must not interfere with the Competition Practice Schedule, which must take priority.  
Any display, demonstration or show must not interfere with competition flying.

- 1.11 The Host National Aero Club may accept participants for outside the competition but without causing any interference to the Championships. Their results will not be shown on any competition list. Only individual results may be handed to them.
- 1.12 The Host National Aero Club will take out adequate insurance coverage for all personnel who for any reason have to be present, close or adjacent to the competition area, either in practice or in competition. This will include all Jury Members, Judges, operational officials, secretaries, team managers or other crews observing practice.

## **2.0 VENUE**

- 2.1. When choosing the location of a Championship site careful consideration should be given to the type of terrain readily available. Mixed terrain, both low lying and high ground is recommended, in an area that is neither too easy nor too difficult to navigate over.
- 2.2 It is preferable to have the sole use of an airfield or be able to adopt a dominant role in respect to air traffic movements.
- 2.3 The navigation area (Event 1), where competition traffic is relatively low, military low level flights through the area are unacceptable. Appropriate Notams must be issued in respect to low level helicopter flying especially for manoeuvring and searching.
- 2.4 For Event 1, the whole of the navigation course must be on one map.
- 2.5 For Event 1, there should be no prohibited areas or danger areas within 10 nautical miles of the navigation route. There should be no dangerous power cables within 3 NM of the airfield. Cables must be shown on local area but not competition maps.
- 2.6. The airfield should have a large open unrestricted grass area upon which the championship tasks can be carried out. Routing in and out of the airfield should be from different directions, pre-planned and marked on the ground for all events taking place on the airfield.
- 2.7 Seating areas (low level stands) should be available for spectators within reasonable distance of the competition area. Separate facilities must be provided for international press including TV and Sponsored video teams. A separate press centre should be made available by the Organizer.
- 2.8 The airfield must provide adequate full time air traffic control, fire and ambulance services, hangarage for special maintenance, fuel both for piston and turbine helicopters. A fast refuelling facility on the airfield is vital for the smooth running of a championship.
- 2.9. Catering facilities, for the sole use of those associated with the championship, must be provided. The Organizer should allow for staggered mealtimes i.e. running continuous buffet.

- 2.10 The airfield should be located not more than 20 minutes travel time from the residential accommodation provided for the participants.
- 2.11 The airfield should be available for full familiarisation and practice in the week prior to the championship, during which time the airfield will be run under strict Local Rules to which all participants must adhere. In the event that a military base is used the Organizer must provide an alternative training airfield nearby to the navigation area in order that navigation training may take place in the week prior to the championship.
- 2.12 A detailed weather history within the competition area must be provided to FAI – CIG at the time that the bid is made.
- 2.13 Special attention should be given to the location and size of the briefing and rest room. This should not be used for catering purposes. Sufficient seating should be provided for a minimum 150 people with additional facilities for press and TV crews.

### **3.0 SPONSORSHIP**

- 3.1. The Host National Aero Club is encouraged to obtain sponsorship either for the whole or for individual events within the championship in order that the overall cost of the event for participants is reduced.
- 3.2 Hosting championships should not be taken by the National Aero Club as a means of making substantial profit at the expense of the participants.

### **4.0 PRESS AND TELEVISION (The Media)**

- 4.1. FAI – CIG will, in considering bids for hosting Championships, put considerable emphasis upon the quality and coverage given by International, Continental and Local Media. This is particularly important in the case of television.
- 4.2. Facilities must be available for international and local press, television and video crews. It is essential that there is wide coverage both nationally and internationally. Details of daily international and national programme coverage must form part of any bid.
- 4.3 The Organizer will provide facilities for press and television. This will include appropriate stands in the vicinity of the competition area on the airfield. Television crews must be escorted into the competition area but not the navigation area, but they cannot be accompanied by more than 2 others. (Maximum 3) They must be escorted at all times by a member of the Championship Director's staff whose duty will be to ensure that they do not interfere in any way with competition flying, judging or cause a hazard.
- 4.4 The Host National Aero Club will provide an experienced commentator who can provide an exciting, interesting and regular flow of information and results to be broadcast to the public enclosure and to the briefing area.

- 4.5 Facilities will be made available for the broadcast of music used during the freestyle event. It would be an advantage to have a practice prior to the championship to facilitate smooth running of the event. The position of loudspeakers must be placed so that competing pilots can clearly hear them.

## **5.0 ACCOMMODATION**

- 5.1 It is beneficial but not vital for all participants to be housed together in one complex. This will reduce the problems of communication and enables a central information centre to be set up. Competitors must have priority over supporters.
- 5.2 The cost of accommodation is of prime importance to participants. Expensive hotels are unwelcome. Participants require reasonable accommodation at an acceptable price.
- 5.3 The accommodation should provide for a running breakfast timings of which will be governed by the competition programme.
- 5.4 The residential site must be within easy reach of the competition airfield. The Competition Management must be sympathetic to pilots rest requirements.
- 5.5 It is essential that absolute quiet is given between the hours of 23.00 – 06.00 to give sensible sleep periods. Once participants have taken up residence, no parties will be held in the residential accommodation between these times until such time as the last competition event has been completed.
- 5.6 Alcohol will not be sold to competitors after 23.00 hrs in the residential accommodation.
- 5.7 National Team Managers must ensure that supporters do not interfere or disrupt the sleeping period 23.00 – 06.00 under any circumstance.
- 5.8 Two officials will be available between 06.30 and 23.30 throughout the Championships to assist with problems relating to accommodation and transportation. Their telephone numbers must be available to all participants.

## **6.0 CATERING**

- 6.1 Breakfast will be taken at the residential accommodation.
- 6.2 It is recommended that airfield catering is provided on the basis of a running buffet to cater for the staggered requirements of all participants in the championship. Regular hot and cold drinks should be available at all times. The catering area should be designed to provide seating accommodation of 150 at any one time.
- 6.3 Self service is recommended.
- 6.4 The Host National Aero Club will arrange for the Opening and Closing Ceremonies to be held on the airfield or other suitable place in front of the public. Opening and Closing

Banquets may be held at other venues away from the airfield and may be separately sponsored. Any event away from the airfield or the residential area must have a transport service provided for all participants.

- 6.5 Consideration should be given to the provision of vegetarian or other special catering needs. The entry form should require the appropriate information to be given well in advance.

## **7.0 TRANSPORT**

- 7.1 The Competition Management must arrange suitable daily transport between the residential site and the airfield. Pick up points and timetables must be provided to every participant and must be published on an information board both at the residential site and in the briefing room.
- 7.2 It would be ideal for each team to be provided with separate transport. In the likely event that this is not feasible an adequate coach service must be provided.
- 7.3 The Jury, as well the Chief Judge and the Deputy Chief Judge must be provided with their own independent transportation.
- 7.4 Transportation must also be available to take teams of judges and assistant judges out to and return from the navigation area.

## **8.0 AIRCRAFT HIRE**

- 8.1 The Host National Aero Club must be prepared to initiate arrangements for the hire of helicopters for participants unable to bring their own competition aircraft.
- 8.2 Crews planning to hire helicopters should initiate a request at least 3 months before the event specifying type, length of time, hours to be flown, etc. They should furnish full details of their own licences and experience.
- 8.3 Helicopters for hire should be checked by the Host National Aero Club to ensure that they are of an adequate standard for competitive flight and that Certificates of Airworthiness and Third Party Liability Insurance are included.

## **9.0 TRAINING PRACTICE**

- 9.1 Practice and familiarisation of the navigation area should be available in the week prior to the week of the Championship.
- 9.2 Navigation practice should take place without affecting the normal airfield routine.

- 9.3 During practice it is essential that Airfield Routine Regulations are fully observed. It is also necessary for other non competitive traffic using the airfield, to be under similar guidance. Strict RT control will be necessary.
- 9.4 Daily flying should be restricted to 09.00 – 18.00.
- 9.5 Training practice must not be interrupted for display, show or exhibition flights.
- 9.6 The Host National Aero Club must provide a sample of the competition map for approval by FAI – CIG at least 6 months before the start of the championship.

## **10.0 BRIEFINGS**

- 10.1 General and event briefings must be attended by all concerned.
- 10.2 The Opening General Briefing must be attended by Judges, Operational Officials, Team Managers and Crews. The object is to explain the running of the championship, the programme to be adhered to including the social programme and channels of communication.
- 10.3 Event Briefings must be attended by Judges, Operational Officials, Team Managers and Crews. The Briefing will define operating procedures. Discussions on the Rules and judging will not be allowed in briefings.
- 10.4 Daily Briefings must be attended by Team Managers the object being to define the day's programme.
- 10.5 Set Briefings will be attended by crews and team managers.

## **11.0 METEOROLOGY**

- 11.1 A meteorological service must be available, at least on phone or fax, throughout the Championship.
- 11.2 At the General Opening and the Event Briefings a competent person must give a detailed weather briefing.



# World and Continental Helicopter Championships

## Chapter 4

### CRITERIA AND APPROVAL OF JUDGES

- 1.0 This Chapter describes the standard, which must be met by individuals who wish to be granted or maintain the qualification of International Judge as awarded by the FAI - CIG.
- 2.0 **Authority**
  - 2.1 The National Aero Club is responsible for submitting a list of individuals who are to be granted or confirmed as International Judges at the scheduled CIG annual meetings.
  - 2.2 Each NAC is responsible for confirming the training, experience and standard of each of the Judges submitted by the NAC's list together with a brief description of the national training and endorsement procedure. The NAC must endorse the qualifications as laid down in 4.1 to 4.3.
  - 2.3 Should it be found that a Judge does not meet the standards set by the CIG then the Delegate of concerned NAC may be requested to explain at the next FAI - CIG meeting.
- 3.0 **Duration**
  - 3.1 The validity of International Judge status will be from one CIG meeting prior to a World or Continental Helicopter Championship to the next. This will give a validity of two or maximum three years depending on the frequency of these Championships.
  - 3.2. It is in order for the CIG to convene a special meeting at a World Championship to appoint more International Judges provided the Judges are approved by their NACs and its delegate as well as complying with CIG standards.
- 4.0 **Standards**

An International Judge must be able to demonstrate the following ability:

  - 4.1 Rules: A full knowledge of the current version of the CIG World and Continental Championship Rules and regulations of FAI Sporting Code General Section.
  - 4.2 Physical capability:

An International Judge and Assistant Judge must be capable of remaining out in the field for at least 10 hours. They must also be sufficient mobile to move fast within the competition area.

**Eyesight:**

To be able to read two numbers each 30cm x 30cm as described in 13.9 of the Chapter 2, from a distance of 15 Metres or 50 feet.

**Hearing:**

To be able to hear a helicopter approaching in still air conditions from a distance of 1 NM.

A holder of a valid aviation medical of any class will be assumed to meet these criteria.

**Stopwatch Usage:**

To be able to demonstrate familiarity with a stopwatch of his choice, or the approved *NAC* stopwatch and to be able to measure a time to an accuracy of 0.25 of a second.

**Clock Usage:**

To be able to synchronize a clock to a Master Clock to an accuracy of 0.1 of a second and to time an event to an accuracy of 0.25 of a second.

**Speed, Height, Course judgment.**

To be able to determine a course change of over 30 degrees, a ground speed of less than 30 kph (16 kt), and a height of 10 metres (33 feet).

- 4.3 A Judge must have been a major Official i.e. Chief Judge, Deputy Chief Judge, Jury Member or have judged in either a World or Continental Championship or World Air Games, International Sporting Events, National- or Open National Championships, which have been carried out in accordance with FAI – CIG Event Rules and Regulations within the last two years prior to the deciding CIG meeting.
- 4.4 A Judge not meeting any of the above criteria may be appointed an Assistant Judge at the discretion of the CIG providing an experience/training declaration (Annex C) has been submitted.

# World and Continental Helicopter Championships

## Chapter 5

### Event Rules and Regulations

#### 5.0 General

The events described in this chapter should also be used for National Championships and other National or International sporting events or for special air sports presentation and other contests organized by or on behalf of a National Organisation. At Organizer`s discretion the events 2, 3 and 4 may be carried out as single courses.

#### Event 5.1 - Navigation

(to be read in conjunction with the General Section of the Sporting Code Annex A)

##### 5.1.0 Event Description:

The Event is a Navigation with Timed Arrival and Load Drop Off .  
The Event will include a navigation course; en-route search zone on second or third leg; aerial drop zone between Departure line and MFO 1 or on the first leg of manoeuvring box; timed arrival at Line “A”; manoeuvring box between Line “A” and Line “F”; a load drop off at Line “C”; and end-of-event landingzone.

##### 5.1.1 Navigational Course.

The navigation course will include 6 legs; three (3) Turning Points (TPs) and two (2) Mandatory Fly Over (MFO) points.

LEG	FROM	TO
1st Leg	Line “D”	MFO 1
2nd Leg	MFO 1	TP1
3rd Leg	TP 1	TP2
4th Leg	TP2	TP3
5th Leg	TP3	MFO 2
6th Leg	MFO 2	Line “A”

TP1, TP2 and TP3 will be identified on the ground by orange 2 x 2 metres triangular panels with black numbers on them. The competitor must identify each sign at its specific location. Intermediate time will be recorded at TP1, TP2 and TP3 for control purposes only.

The route, including identification of panels will be about 70 – 90 kilometres. The route length and the location of the targets for the bags will be announced at the event briefing.

##### 5.1.2 Flight Height:

The route and the MFOs will be flown at a height of about 250 metres AGL. Turning Points plus search zone entry and exit gates markers shall be overflown at a height of 50 metres if not increased to meet national regulations of Organizer`s state.

### 5.1.3 Flying Time:

Identical for all competitors of the same helicopter type. The flying time will be computed by the Organizer based on the speeds defined in para 12.9 of the Chapter 2 listed by type in Appendix A. For safety reasons and due to various weather conditions, an additional time of at least 3 minutes will be added to the calculated flying time for each competitor.

### 5.1.4 Start Time:

Start times will be given in exact minutes and seconds.

There are penalties for early and late departure. During the event briefing each crew will receive the time the helicopter has to be at Preparation Line and the exact departure time the helicopter has to pass the Line D. Departure Time will be as appropriate to ensure proper aircraft separation.

### 5.1.5 Preparation line:

Ten (10) minutes before departure time the helicopter will come to the preparation line (Line "P"). At the preparation line, the Organizer's designated event official will give to the crew, the skittle with rope attached, and two (2) numbered fabric bags (filled with rice or sand, each weighing 1 kilo).

### 5.1.6 Departure line:

The helicopter will then move to and land in front of the Departure Line (Line "D"). A sealed envelope containing the Competition map and instructions will be given to the crewmember at Line "D" exactly 5 minutes before the scheduled departure. The envelope must be retained for handing in results at the end of the event. All helicopter doors must be fitted.

The sealed envelope will contain the following information:

- + The flying time for the event from Line "D" to Line "A" will be stated on the outside of the envelope.
- + The calculated flying time from scheduled departure to arrival at the search zone exit in accordance with 5.1.3 and the distance.
- + The true course from the departure line to the first MFO.
- + Geographical position of TP1 and TP3, in latitude and longitude.
- + Schematic of the search zone.
- + The Competition map with the following information indicated:
  - The position of MFO 1 and MFO 2
  - The position of TP 2
  - The search zone
  - The entry and exit gates of the search zone
  - Target panel locations

No other map than the competition map provided by the Organizer will be allowed on board during this event. Other maps should be surrendered. Infringement will incur a penalty of 100 points. In the interest of safety an ICAO 1: 500,000 map will be permitted in a sealed envelop or box.

#### 5.1.7 Departure:

The helicopter will depart Line “D” on its given departure time. Early or late departures will be penalized.

#### 5.1.8 Search Zone.

The search zone will include ten (10) 3 x 2 metre orange panels, on which black letters or signs will be painted. The entry and exit gate will be marked on the ground by one metre wide and 15 m long white stripes, with the I (in) and O (out) orange panels in the centre space of five (5) metres. The competitor must identify each sign at its specific location.

Penalty points will be incurred for not vacating the search zone on time, and for not entering or exiting the search zone correctly through the 35 metre entry and exit gates. The panels must be placed in such a manner that the distance covered to overfly all search zone panels is less than 10 nautical miles (18.5 km).

#### 5.1.9 Leg TP3 to MFO 2:

The helicopter will be flown from TP3 to MFO 2 in a straight line.

#### 5.1.10 Enroute Drop Zone:

In a determined drop zone (location as described in para 5.1.0), the crew will drop a bag on each of the two five (5) metre diameter target circles, which are marked on the ground and 100 metres apart in the direction of flight.

Dropping the bags will be performed at a height of not less than ten (10) metres AGL and at a minimum ground speed of 30 kph.

The time elapsed between the first and second bags touching the ground shall not exceed 12 seconds.

The compulsory target order is “Target One” then “Target Two”.

Where the bag hits the ground first will be considered the impact point for scoring purposes.

#### 5.1.11 Leg MFO 2 to Line “A”:

The helicopter will be flown from MFO 2 to Line “A” in a straight line.

The descent will start progressively in the last 3 kilometres, in order to pass vertically over Line “A” at a height of 30 +/- 15 metres AGL.

Ground speed less than 30 kph during the last two (2) kilometres to Line “A” will be penalized for each infringement. The landing light must be on for the final two (2) kilometres.

#### 5.1.12 Arrival Line “A”:

Line “A” will be identified on the ground by one (1) metre wide and two 15 metre long yellow stripes, with a blank center space of five (5) metres.

#### 5.1.13 Determining Arrival Time:

The time will stop when the nose of the helicopter crosses Line “A” or its extensions to left or right side.

#### 5.1.14 Manoeuvring Box Line “A” to Line “F”:

After crossing Line “A”, the helicopter will fly a rectangular box.

All competitors will perform turns in the box in the direction assigned during the pre-event briefing (see drawing, Annex 1).

This is a timed manoeuvre. Imposed flight time between line “A” and line “F” will be 1 minute. Time begins when the nose of the helicopter crosses Line “A” and stops as the nose of helicopter crosses Line “F”.

The descent will take place inside the manoeuvring box. Any hovering between Lines A and F the will be penalized for each infringement.

#### 5.1.15 Line “F”:

The helicopter will pass Line “F” at a height of 15, +/- 5 metres. Passing Line “F”, the competitor will continue in a straight line to reach the target (Dog House) positioned 50 metres after line “F” ( see drawing, Annex 1 ) to put down the load.

#### 5.1.16 Dog House and Load Put Down.

The target (see drawing, Annex 2) is composed of two white 2 x 2 metre panels, assembled at an angle of 90 degrees, resting on the ground and forming two 45 degree angles. The load-receiving hole is a 0.4 x 0.4 metre square, the centre of which is one metre above the ground. Only the hole facing the arrival direction will be valid for scoring.

The crew member will, after crossing Line “F”, deploy a rope (see drawing, Annex 1) seven (7) metres long, on the opposite side to the pilot, at the end of which a skittle will be attached.

This is a timed manoeuvre. Maximum time between Line “F” and releasing the rope is 20 seconds.

The rope must be fully extended and free of knots prior to crossing the line five (5) metres short of the dog house. Hovering between Lines “F” and the Dog House (Line“C”) is permitted.

The rope must remain held at a grip at its end by the crewmember who must have both hands visible to the judges.

Manoeuvring of the rope is allowed provided the rope is not shortened by any part of the body below the red flag.

The crewmember will remain fastened and seated on his seat at all times.

The crew must put the skittle into the square hole without touching the surface of the doghouse releasing the rope as soon as the exercise is finished. The doghouse open sides are not part of the roof. Time stops when rope is released.

If the skittle is dropped in the box, penalty points will be incurred for every tenth of a second above 20 seconds from Line “F”. A skittle dropped outside box incurs 30 penalty points.

#### 5.1.17 Landing Zone:

A 10-metre landing zone next to the Dog House will be designated for the competitor to handover the envelope.

The Landing Zone is positioned at a safe distance from the Dog House (approx. 25 - 30 metres). Competitors who do not land in the Landing Zone receive 30 penalty points (see infringements).

Immediately after landing in the Landing Zone, the crew member hands to the Judge, the envelope containing the identification sheet for the ten panels and turning points

and the competition navigation map. The competitor's competition number and/or name will be clearly featured on the outside of the envelope, on the map and on the identification sheet.

#### 5.1.18 Disqualification/Black Flag:

A competitor will be disqualified during the event if any of the following situations should occur:

- A black flag will be shown at Line "A" when a competitor is more than 200 seconds early or late on his given time of arrival. In such case the competitor may be waved off and should vacate the vicinity of Line "A" immediately to avoid conflict with the next aircraft, and return directly to the landing zone.
- If the rope is caught on the helicopter as it departs pulling or dragging the Dog House, this will be considered as unsafe flying.
- For any flight violation and/or unsafe flight manoeuvre / act during the event including aircraft movement to and from the aircraft parking area, i.e., parking area to the preparation line or from the landing zone to aircraft parking area.

#### 5.119 Tie Breaker:

If there is a tie for a place, the crew with the most accurate arrival time at Line "A" will be the winner. Should these times be the same, then the shortest time between "F" and "C" will be used to determine the place.

#### 5.120 Scoring:

$300 - P = \text{Score}$ . Score is determined by subtracting the Penalty Points from 300. The minimum score achievable is zero.

## SCORING – EVENT No. 1 (Navigation)

EVENT 1 INFRINGEMENTS	PENALTY POINTS
Early departure from Line “D”	100
Not departing Line “D” within 15 seconds of Departure Time	50
Each missed, not correctly passed or not identified number of Turning Point	20
Entry outside the gate to the Search Zone (not using the Entrance Gate)	10
Exit outside the gate of the Search Zone (not using the Exit Gate)	10*
Each Target/Panel in Search Zone missed or incorrectly identified	10
Each tenth of a second late in exciting the Search Zone (maximum 50 points)	0.1*
Early exit from the Search Zone by more than 5 minutes (300 seconds)	50
Bag not hitting a target circle	5
Violation of the minimum dropping height	10
Violation of minimum dropping speed. More than 12 seconds between bag impacts.	10
Bags dropped in the wrong order	5
Ground Speed less than 30 kph during the last 2 kilometres before Line “A”	10
Missing Line “A” ( crossing Arrival Line outside given dimensions of 35 metres )	10
No landing light “ON” during the last 2 kilometres before Line “A”	5
Hovering ( no visible or measurable forward motion ) during the last 2 kilometres before Line “A”	30
Each tenth of a second early or late on Line “A”	0.1
Early or late arrival over 200 seconds at Line “A” Disqualification	300
Omitting any of the manoeuvres after passing Line “A”	30
Each tenth of a second early or late on Line “F”	0.1
Each tenth of a second more than 20 seconds between Line “F” and Line “C”	0.1
Each hovering event ( no visible or measurable forward motion )	
Between Line “A” and “F”	30
Each contact of the skittle with the ground between Line “F” and Line “C”	5
Crew not remaining seated or fastened (both hands and legs not visible)	30
Rope shortened, or has knots, or handled below red flag	30
Rope not deployed 5 metres before the dog house	10
Each touch of the skittle on the Dog House roof	2
Skittle dropped outside the Dog House Box	30
Unsafe flight manoeuvre, violation or act before, during or after the event	300
Not Landing in the 10 Metre Zone	30

\* If the judges see a helicopter passing outside the 35 m exit gate they stop their watches when the helicopter crosses the extensions of left or right side of exit gate. If a helicopter exiting search zone is not seen by judges at exit gate the competitor will be penalized 50 points.



**Annex 1 - Event 5.1 Example of the Navigational Course**  
**NOT DRAWN TO SCALE**

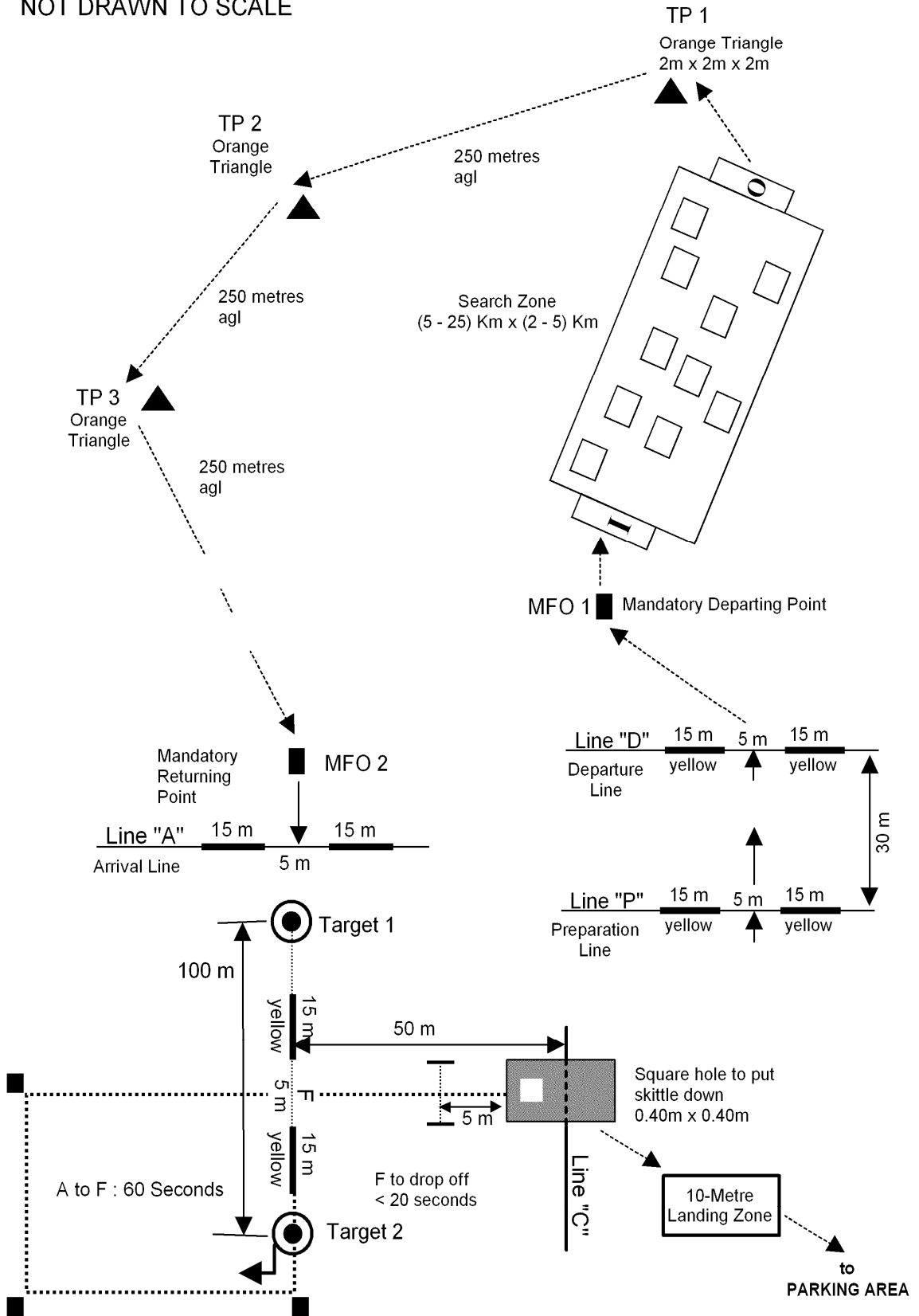

**Annex 2 - Event 5.1 Dog House and Load Put Down**

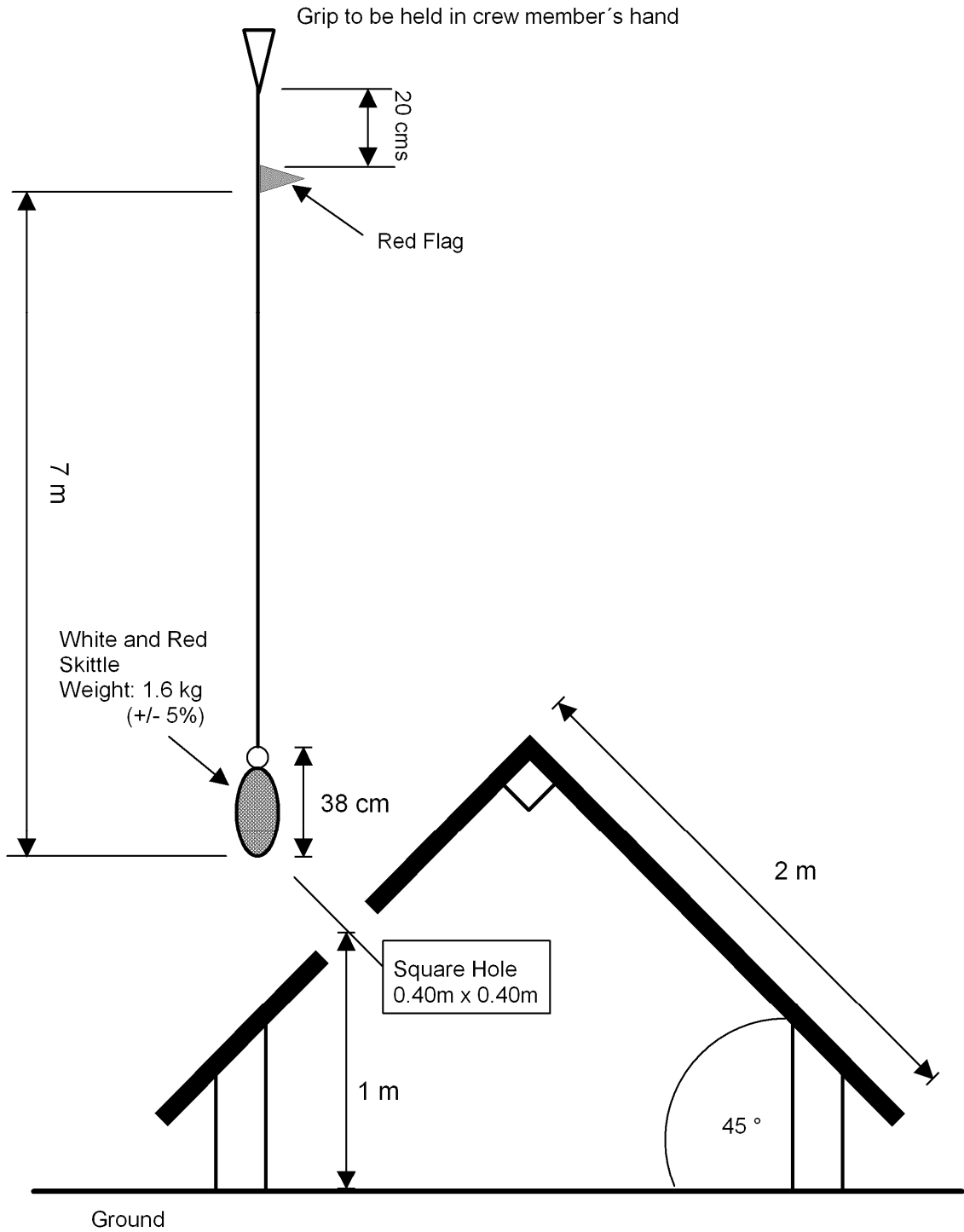

Annex 3 - Event 5.1 - Search Zone Details

Details of the Search Zone  
Examples of a Schematic given to the Competitors

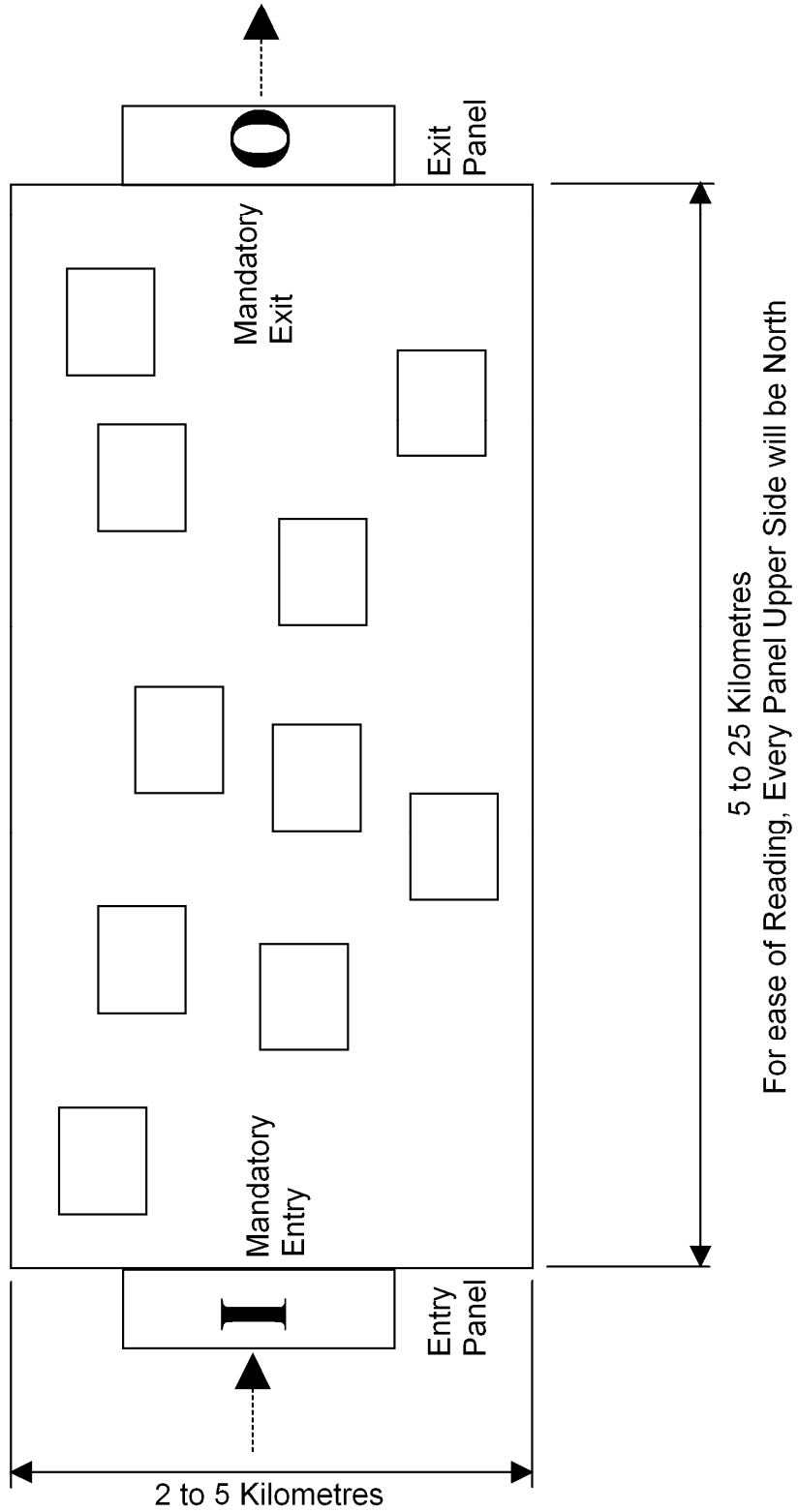

Annex 4 - Event 5.1 - Type of Panel to be used



Letters and Signs will be Black on Orange Panels.  
Size, 3 Metres Wide and 2 Metres High.

## Event 5.2 – Parallel Precision

### 5.2.0 Event Description:

The event will be flown with two competitors at the same time on parallel courses. The event requires constant height, low level flying with manoeuvres on a course, of which the basic parameters are known with the details as described in 5.2.6 and Annex 1. The choices as listed in 5.2.9 will be made public by the Championship Director at the event briefing.

The course should be laid out against the wind direction.

### 5.2.1 General Requirements:

The helicopter will be flown with all doors on and closed. Arched cockpit doors certified by the manufacturers may be used. Special window bubbles in cockpit doors are not permitted.

The crew member must stay within the helicopter, on his seat and in the normal position.

The crew must install the attachment points for the ropes and the tape markings on both sides of the fuselage, skids or wheels before the competition.

These attachment points are such that when the helicopter is on the ground the ends of both attachment points are just touching the ground. There will be a loop at the end of each attachment point, and each attachment point strong enough to hold a weight of 5 kg.

The shorter rope attachment point should be clearly marked.

During the morning briefing, competitors will receive their start time at which the helicopters must be at the preparation line.

### 5.2.2 Composition of the course:

The course is composed of two parallel corridors, having a length of 50 metres and a width of 1 metre, identified by ground markings. The distance between the corridors is at least 60 metres. At both limits of the corridors, perpendicular corridors with a length of 10 metre to each side, are marked on the ground. Additional two flag marks will be placed every ten metres left and right of each perpendicular corridor. These additional corridors and marks are to assist the pilots to hold the helicopter in the 1 metre square at the corridors limits during turns.

The arrival lines “A” will be 20 metres from the end of the two corridors, and will both be 5 cm wide and long enough to be visible on both sides of the helicopter by the crews.

### 5.2.3 Flight Height Control:

Two ropes or suitable chains or a combination of both will be attached by judges/assistant judges, the shorter one attached to the aircraft fuselage under the pilot's seat, the longer attached to the rear end of the skid opposite to the pilot side, as far as possible from the first rope/chain (see drawing, Annex 3). The rope/chain lengths are exactly 2 metres for the first one and exactly 3 metres for the second one, being measured from the lowest point of the undercarriage (skid or wheel) to the lowest end of the weights. For a better make-out the ropes/chains may be painted red or orange.

#### 5.2.4 Preparation line:

The competitor will come to Line P (Preparation).

Judges will connect the ropes to attachment points provided by the competitor and will check the positioning of the two tape markings, as chosen by the competitor on both sides of the fuselage, or both skids or both wheels.

At the Line P, the crews are allowed to lift the helicopter into a hover with the crew member either inside or outside the helicopter to communicate to the pilot the height of the helicopter and the status of the weights. One 360 degree clockwise turn and one 360 degree anticlockwise turn is permitted to ensure the weights are attached safely. The helicopter should then land again. Judges are not allowed to make any indications to competitors during this procedure.

#### 5.2.5 Departure line:

The helicopter will be landed on Line D. Upon an indication of ready from both pilots or crew members and when the course is clear of the previous competitors, the judge will signal the start by dropping a flag or the use of a suitable indication system, which must be demonstrated to the competitors at the morning briefing. The time starts.

#### 5.2.6 Manoeuvring through the course:

The competitors will fly the ground marked courses, maintaining a height ranging from 2 to 3 metres, keeping the bottom weight on the ground and the top weight off the ground.

The corridors will be flown 5 times. First time from Line D forward with a 360 ° turn at the corridor's upper limit. Second time returning backwards to the first end with a 90 ° turn at the limit. Third time sideways with a second 360 ° turn at the upper limit. Fourth time returning sideways to the first end with a 90 ° turn at the limit. Fifth time forward passing over the limit of markings and landing exactly on the arrival line.

The landing must be performed in one try. Slide and double landings will be penalized.

The competitors will perform the 360 ° turns around the yaw axis, one turn will be clockwise and the other anti clockwise. Each turn must take a minimum time of 15 seconds.

Performing the 90 ° turns, the first turn will be anti-clockwise and the second clockwise.

#### 5.2.7 Measurements:

Corridor and height violations will be recorded in cumulative tenths of a second. Final times will be rounded to the nearest tenth of a second as described in Chapter 2 para 13.14.

The violation of corridor limits is defined as when the attachment point of the shorter rope (2 meters long) is outside the corridor limits marked on the ground.

The violation of height is defined as when either the short rope touched the ground or the end of the long rope is off the ground from a height above 3 metres.

The measurement on Arrival line A will be from the forward limit of the tapes installed on the helicopters (skids or fuselage) to the nearest limit of 5 cm arrival line. A forward limit of the tape within the 5 cm arrival line counts as 0 cm.

Should helicopter tapes be installed on the fuselage or above ground level, a plumb bob will be used to assist in accurate measurement.

#### 5.2.8 Timing:

The time starts when the start signal is given at the departure line and stops when the first part of the helicopter landing gear touches the ground.

#### 5.2.9 Variables for determining the Direction of 360 ° Turn:

- 1) First turn Clockwise, Second Turn Anti Clockwise
- 2) First turn Anti Clockwise, Second turn Clockwise

#### 5.2.10 Tie Breaker:

If there is a tie for a place, the winning crew is determined by the shortest flight time.

#### 5.2.11 Scoring:

300-P = score. Score is determined by subtracting the Penalty Points from 300. The minimum score is zero.

## SCORING - EVENT 5. 2 (Parallel Precision)

### INFRINGEMENT

### PENALTY POINTS

Each tenth of a second above 2'15" of flight (135 seconds) between Lines D and A *	0.1
Violation of the corridor limits, of the short rope attachment per tenth of a second *	0.1
Each time the bottom weight is off the ground per tenth of a second *	0.1
Each time the top weight touches the ground per tenth of a second *	0.1
Duration of a hovering 360° turn shorter than 15 seconds ***	15
For omitting any of the manoeuvres	25
For each occurrence of a change of heading exceeding 30 degrees	10
Landing scale **	0-120
Double Landing ( after touching ground with any part – Time Stop – the helicopter rises completely free from the ground before next touch down )	25
Slide Landing ( visible and measurable forward motion or turn of the fuselage - skids , wheels - after first ground contact )	25

\* Rounded to the nearest tenth of a second as in para 13.14 of Chapter 2.

\*\* The distance of each skid from the nearest limit of the 5 cm arrival line is measured in cm and added together using 1 penalty point per cm. 120 points is the maximum penalty. Part of a cm should be rounded up to the next full cm.

\*\*\* i.e., turn duration is 14.94 seconds or less.

**ANNEX 1 - Event 5.2 - Parallel Hover Parcours**

NOT TO SCALE

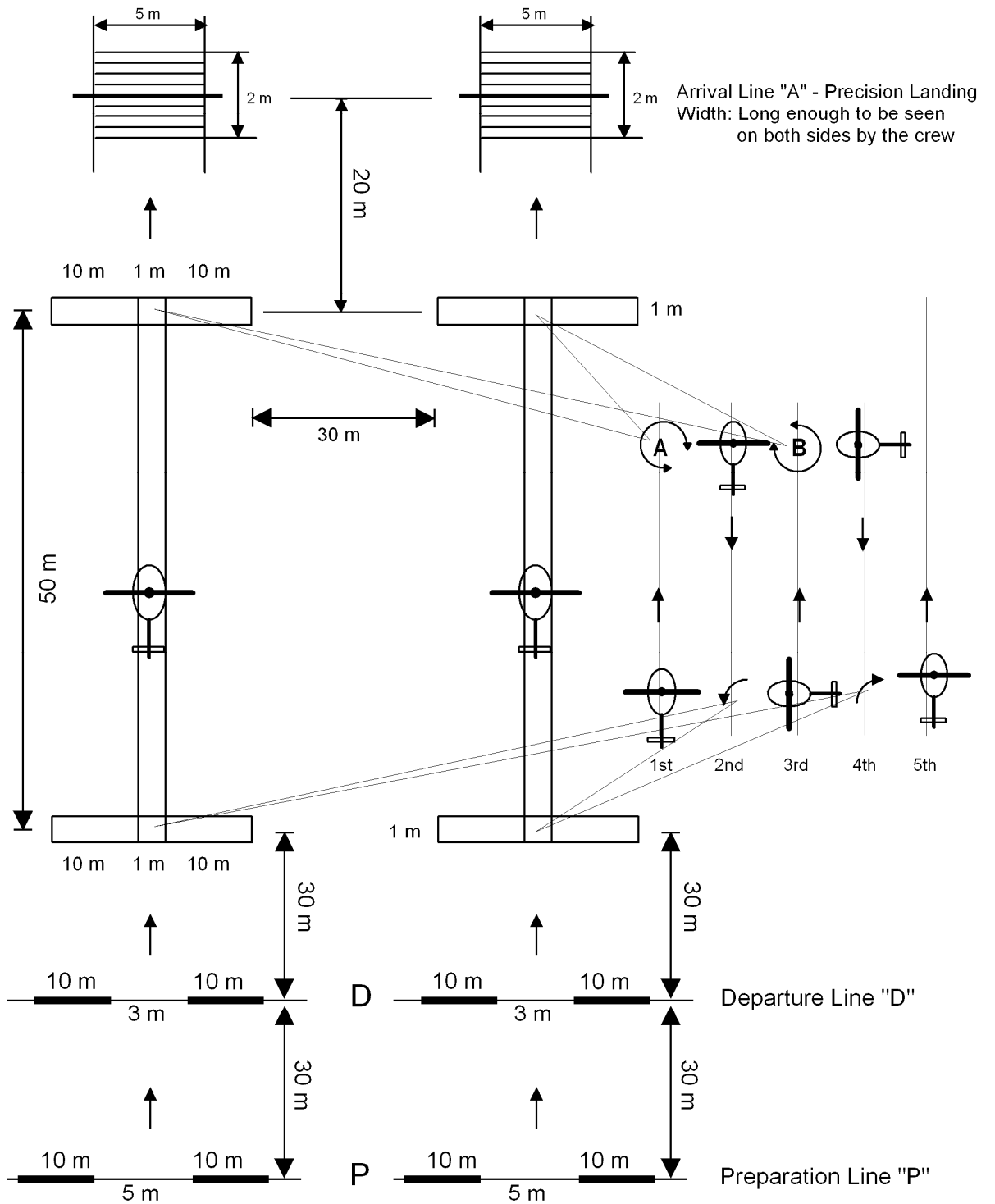



Annex 2 - Event 5.2 - Precision Landing Area

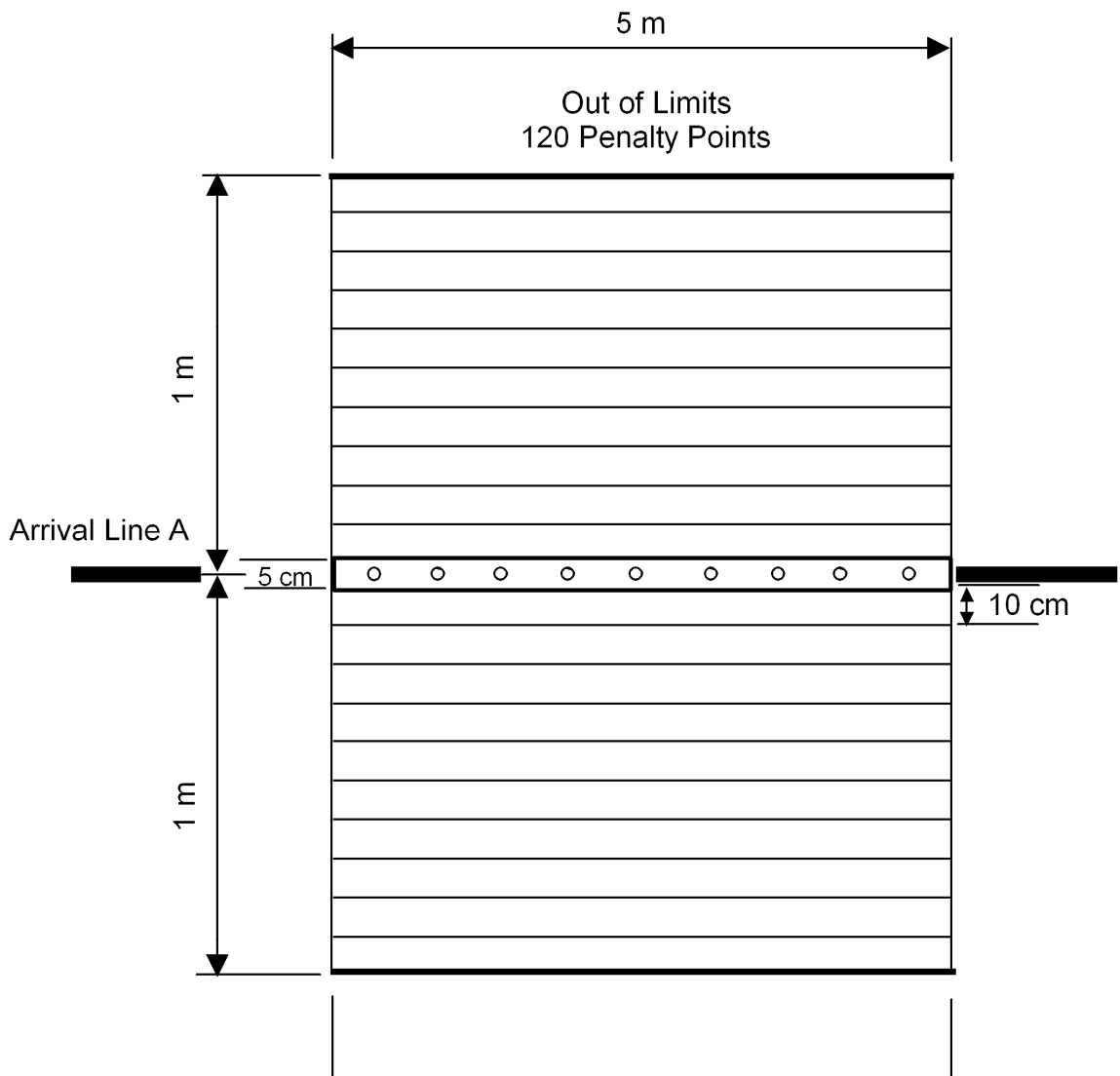

**Annex 3 - Event 5.2** Length and Attachment of Ropes

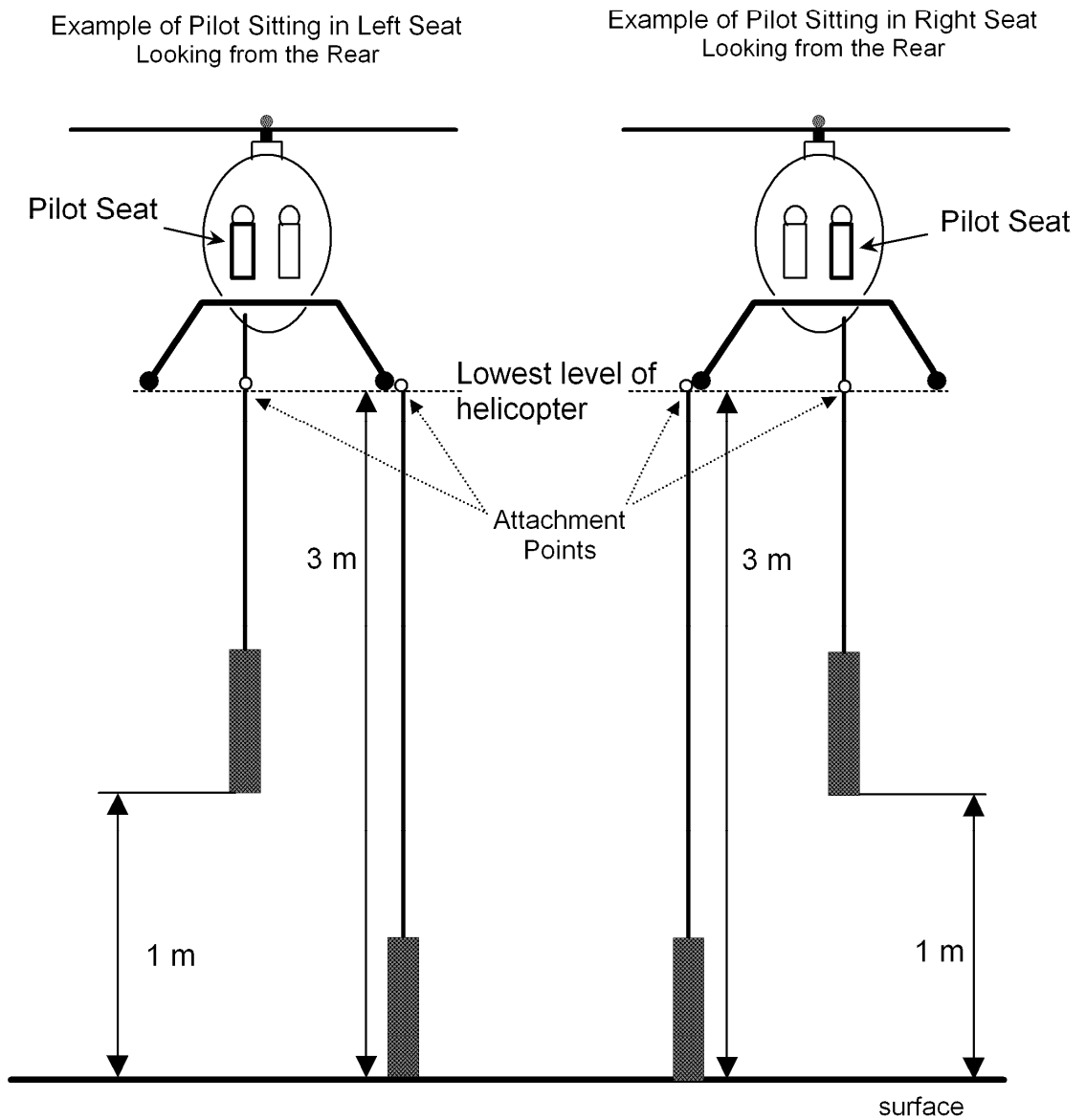

## Event 5.3 – Parallel Fender Rigging

### 5.3.0 Event Description:

The event will be flown by two competitors at the same time on parallel courses. The event requires precise flying with a load ( fender ) and rope lengths in a sequence of 4, 6 and 8 metres, and a flying time of 60 seconds. The direction of flight through each entrance gate is made public by the Championship Director at the event briefing.

### 5.3.1 General requirements:

The helicopter will be configured with a closed door on the pilot's side. Special window bubbles in cockpit doors are not permitted. Outside mirrors and technical aid such as radio altimeters are not permitted and such use will result in disqualification. The crews will be correctly harnessed. The crew members are in the normal seating position, both legs are to be kept within the cockpit. During the morning briefing competitors will receive their time at which the helicopters must be at the preparation line –line P.

### 5.3.2 Departure line:

Once the start positions are free, the responsible judge will call the next competitors from the preparation lines (P-line) forward to the departure lines. The helicopters must land in front of the departure lines. Assistant judges will hand the crew members the fenders with their ropes, each with 3 red flags fixed in distances of 4, 6 and 8 metres from the top of the fender. There are 2 additional wooden balls as handling aid, each 20 cm above the flags. At the end of the rope a grip 20 cm above the 8 m flag is fastened. The fender will remain outside the helicopter on the ground. The crew member will hold the rope at the respective handling aid. Upon an indication of ready from the pilots (or crew members), the judge will signal the start for competitors by dropping a flag or use of a suitable indication system (Such a system has to be demonstrated to the competitors at the briefing). The competition time starts.

### 5.3.3 Manoeuvring through the course:

The pilots will take off and after passing the Gate "D"(marked by flags), fly to the entrance gate. The crew member must manoeuvre the fender through Gate "D" and the entrance gate and into the containers. The rope must be fully extended and free of knots prior to crossing the departure line (D-line). The pilot will fly to the first area, and the crew member will put down the fender into the first container. The rope will remain held at the handling aid above the relevant red flag by the crew member, who must have both hands visible. Manoeuvring of the rope is allowed provided the rope is not lengthened or shortened.

After put down the fender into the first container, the crew member will deploy the rope to the appropriate length for the second container and lift up the fender again from the container.

The pilot must proceed to the next container area. The crew member must manoeuvre the fender through the entrance gate and into the second container. After put down the fender into the second container the crew member will deploy the rope to the length for third container and lift up the fender.

After the third container and letting go of the rope, the helicopter must leave the competition area by passing the exit gate.

#### 5.3.4 Timing:

The time starts when the start signal is given at the departure line and overall time for each crew is stopped when the crew member has let go of the rope.

The total time for this event is a maximum of 60 seconds.

#### 5.3.5 Tie breaker.

If there is a tie for a place, the winning crew is determined by the shortest flight time.

#### 5.3.6 Scoring

$300 - P = \text{Score}$ . Score is determined by subtracting Penalty Points from 300. The minimum score achievable is zero.

### Scoring Event No. 5.3 ( Parallel Fender Rigging )

Infringement	Penalty points
For each tenth of a second flown over total times limits	0.1 *
Touching the external sides of the container with the fender	
For each touch	3
Touching the ground with the fender between D- line and containers:	
For each touch:	10
Fender not put down into the container	50
Fender lost en route	300
Fender put into container with wrong rope length, rope shortened or lengthened ( for each infringement )	30
Crew not staying seated or harnessed:	50
Rope not deployed to full metres or has knots when flying over the D-line or lifting off from containers ( for each infringement )	20
Overfly of the exit gate – helicopter nose is not first part of helicopter to pass the marked gate or the helicopter does not pass the gate at all for each infringement:	10
Fender not passing the Gate “D”	10
Missing the Entrance-Gate by missing or fender over poles ( for each infringement )	15

\* Disqualification (black flag) if total time exceeds 5 minutes

**Measurements of competition area and equipment (see attached sketch) :**

The competition area is composed of two parallel courses with a space of 30 metres between them. Each competition course consists of:

Preparation lines "P" : two 10 metre- long lines with 5 metres space between the two lines.

Departure lines "D" : two 10 metre-long lines with 3 metres between the two lines, to be positioned 30 metres after the "P" lines.

Three Entrance Gates : Internal width 1 m, composed each of two 2 m high poles.

Three container squares : 40 x 40 metre square, clearly marked, the first to be positioned 20 metres after the "D" line.

Three containers : each to be positioned in a container squares and filled with water or other heavy material to prevent moving.

Measurement of each container:

Height : less than 1.20 metre

Diameter of container opening: 48 cm +/- 2 cm

Measurement of fender:

Diameter of the fender is 30 centimetres

Height : 0,8 metres – 1 metre

Weight of fender (to be achieved by filling with sand or water): 7 – 8 kg

Length of rope 8,20 metres from the top of the fender to the grip.

Red flags at distances of 4, 6 and 8 metres from the top of the fender.

Wooden balls, 20 cm above the red flags at 4 and 6 metres.

The containers and fenders can be made of any material or colour, but must be uniform.

**ANNEX 1 - Event 5.3 Parallel Fender Rigging Parcours**  
 NOT TO SCALE

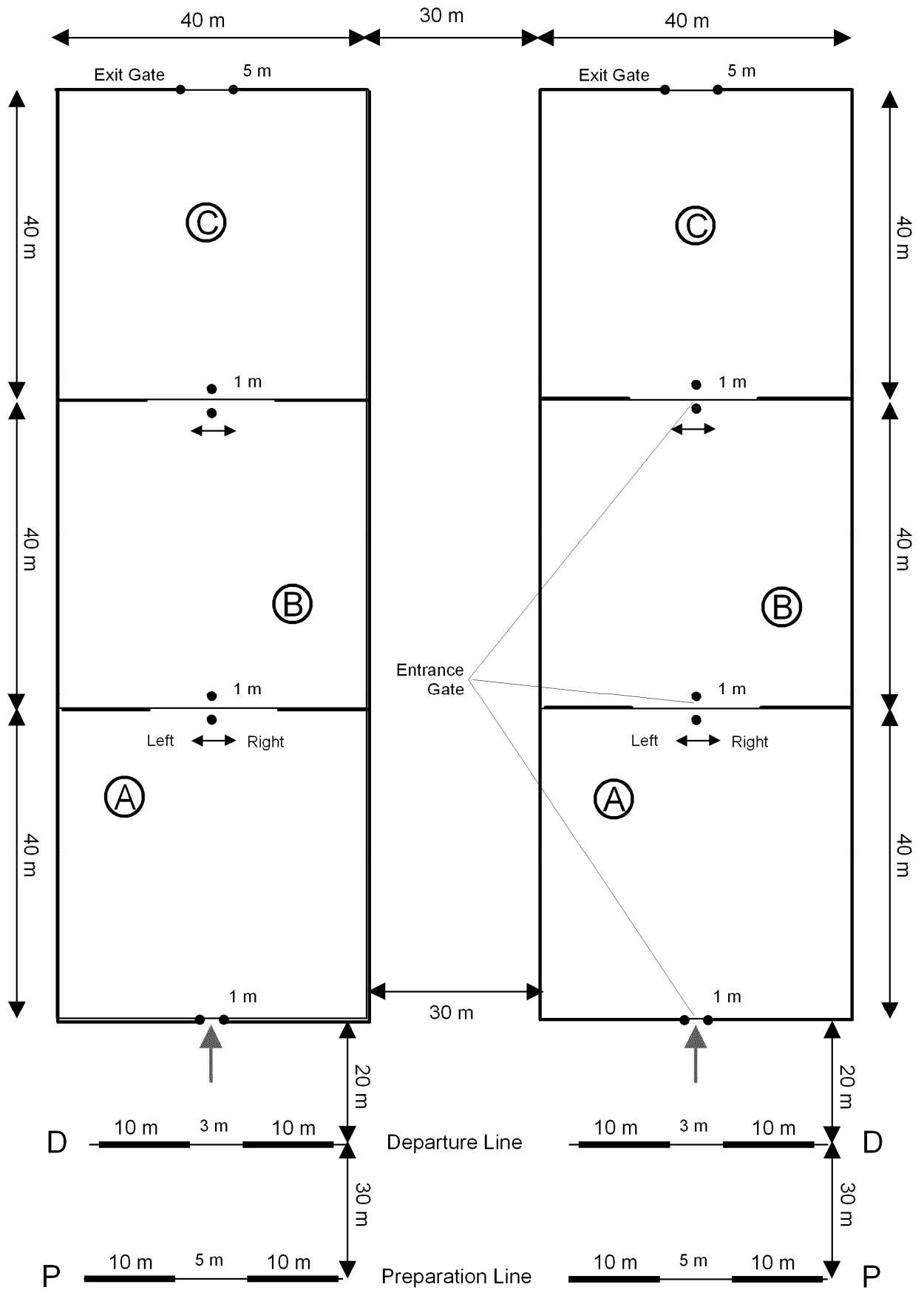

**Annex 2 - Event 5.3** Container and Length of Ropes  
 NOT TO SCALE

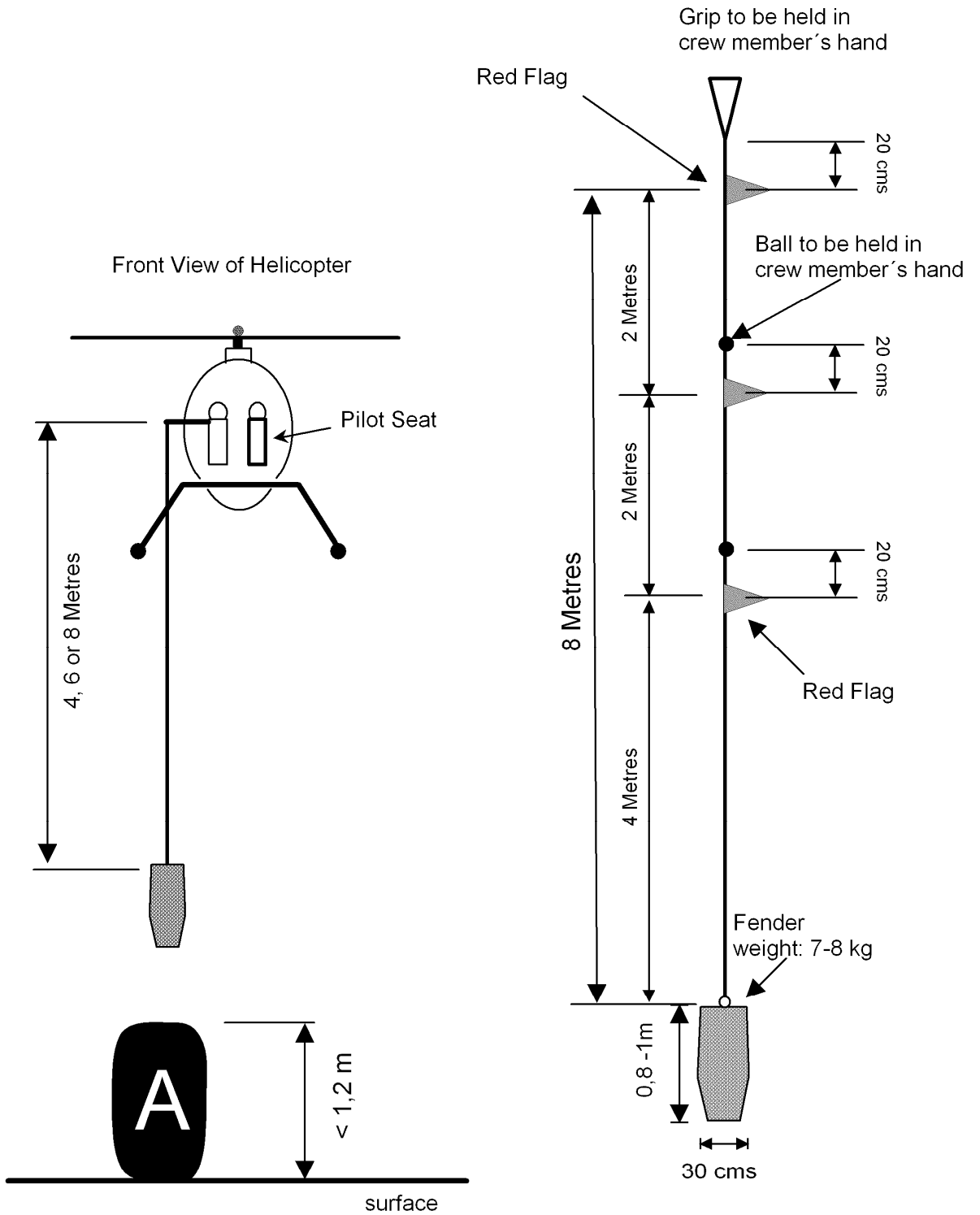

## **Event 5.4 - Parallel Slalom**

### 5.4.0 Event Description:

The Event will be flown by two competitors at the same time on parallel courses. The Event requires precise flying to manoeuvre a bucket, attached to a rope, twice through 6 numbered gates and setting it down finally on a table target. The helicopter will be configured with the pilot's door on and closed. The flying time is limited to 2 minutes and 15 seconds (135 seconds).

### 5.4.1 Preparation:

The helicopters will come to the preparation line and wait for the previous helicopters to finish.

At a signal from the judges, the helicopters will move to land on the Departure line. The Judges / Assistant Judges will hand over the rope with the attached bucket, empty of water. The future water level is determined by 9 lateral holes. The 9 holes will each be of 1cm diameter and the bottom of the holes will be 4 cm from the top of the bucket. ( see drawing Annex 3)

The rope will be held by the crew member, sitting on a seat on the side opposite to the pilot, in a normal position and wearing the safety harness correctly. The crew must remain seated. The rope will be placed on the floor of the cabin, either inside or outside the skids where fitted.

### 5.4.2 Start:

Upon an indication of ready from the pilots (or crew members), the judge will signal the start by dropping a flag or use of a suitable indication system (Such a system has to be demonstrated at the briefing). The helicopters will take off from the Departure Line with the bucket resting on the ground, the crew member holding the rope above the first red flag (3m).

The pilot will fly to the container filled with water. The crew member will fill the bucket with water.

Manoeuvring of the rope is allowed provided the rope is not shortened by any part of the body below the first red flag. After filling the bucket with water, the pilot will increase altitude and the crew member will deploy the 5 metre rope. The pilot will fly to the first gate and the rope will remain held by the crew member by the ball. Both hands must be visible.

### 5.4.3 Course and Gates:

The 6 numbered gates will be placed as per Annex 1 and the gates will be flown consecutively from 1 to 6 and back to 1 in revers order. However the direction of flight through of each gate and the exact position of gates 5 and 6 will be made public by the Championship Director on registration day. The choices are listed in 5.4.7. Arrows will be marked on ground.

To correctly pass a gate, the top of the bucket must pass below the top of the poles. If the bucket misses the gate it must be taken back around the outside of the poles before another attempt is made. Multiple opportunities to pass a gate correctly will be allowed. The judge will score correct or incorrect gate passage when the bucket is flown to the next gate.



#### 5.4.4 Exit and Table:

After passing Gate 1 the second time, the crew member will deploy the 11 metre rope ( Flag No. 3) and the pilot will increase altitude. The rope must be fully extended and free of knots before reaching the 5 metre diameter circle around the centre of the table.

The rope will remain held by the crew member at the grip at its end. Manoeuvring of the rope is allowed provided the rope is not shortened by any part of the body below the upper flag. Both crew member`s hands must be visible.

The bucket must be put down within or as close as possible to the 30 cm centre target, in one try, then the rope must be dropped.

#### 5.4.5 Timing:

The time starts when the start signal is given at the departure line and stops when the rope is released over the table.

#### 5.4.6 Measurements:

Exiting the center target by the outer edge of the bucket will be penalized.

The water left in the bucket will be measured after the competitor has completed.

The measuring will be done on the table and the table wiped dry after the bucket is removed.

Any difference of water level between departure and table will result in penalty points.

#### 5.4.7 Variables:

There will be different gate directions determined by the Chief Judge.

The reference of Up, Down, Left or Right refer to the direction of flight through each gate with reference to Annex 1 with Up being the top of the page.

1) Gate 1 is always flown Up first and Down second time.

2) Gate 2, 3 and 4 Left or Right for both flights through.

3) Gate 5 and 6 Up or Down with exception of gate 6, which will be flown through only once.

4) The position of gate 5 and 6 can vary on their lines within the 30 metres range.

All variables are equal for both courses.

#### 5.4.8 Tie Breaker:

If there is a tie for a place, the winning crew is determined by the shortest flight time.

#### 5.4.9 Scoring:

$300 - P = \text{Score}$ . Score is determined by subtracting the Penalty Points from 300. The minimum score achievable is zero.

## Scoring - Event No. 5.4 (Parallel Slalom)

INFRINGEMENT	PENALTY POINTS
Passing a gate in the wrong order or different direction	20
Failing a gate by missing or bucket over poles	10
Bucket exiting the center target of the table	10
Bucket exiting the table`s 60 cm circle area	20
The bucket exiting the designated area 185 x 50 m	10
Water level – per tenth of centimetre missing *	0.1
Each tenth of a second in excess of 135 seconds **	0.1
Placing the bucket outside the target table *	80
Losing the bucket during the course	300
Rope not deployed before the 5 metre circle around the table	10
More than one attempt to put the bucket down, per try	15
Crew not staying seated or fastened (both hands and legs not visible)	50
Rope lengthened or shortened, has knots or handled below red flag (per each infringement)	30

\* If the bucket fell down from table or landed on the ground, any water left in it will be measured and will incur normal penalties.

\*\* Disqualification (black flag) if total time exceeds 4 minutes.

### Measurements of competition area and equipment ( see attached Annexis )

- 185 x 130 metres rectangular competition area, including two courses (see drawing Annex 1 ).
- Twelve gates, internal width 1 m, each composed of two 2 m high poles.  
( see drawing Annex 2 )
- Two round tables, 1 m diameter and 1 m high. The centre – circles with a diameter of 30 cms, painted in black color. Second circles with a diameter of 60 cms, painted in white color. The remaining surface of the table is painted red.
- Two ropes, equipped with 3 red flags, first 3 m high , second 5 m high and third 11 metres high. 20 cm over 5 m flag a ball to be a handling aid and a grip at its end (see drawing Annex 3).
- Two buckets (see drawing, Annex 3 ) of breakproof material and cylindrical form, containing 6.5 litres +/- 2 % with a maximum total weight of 8,5 kg.

**ANNEX 1 - Event 5.4 Parallel Slalom Courses**  
 NOT TO SCALE

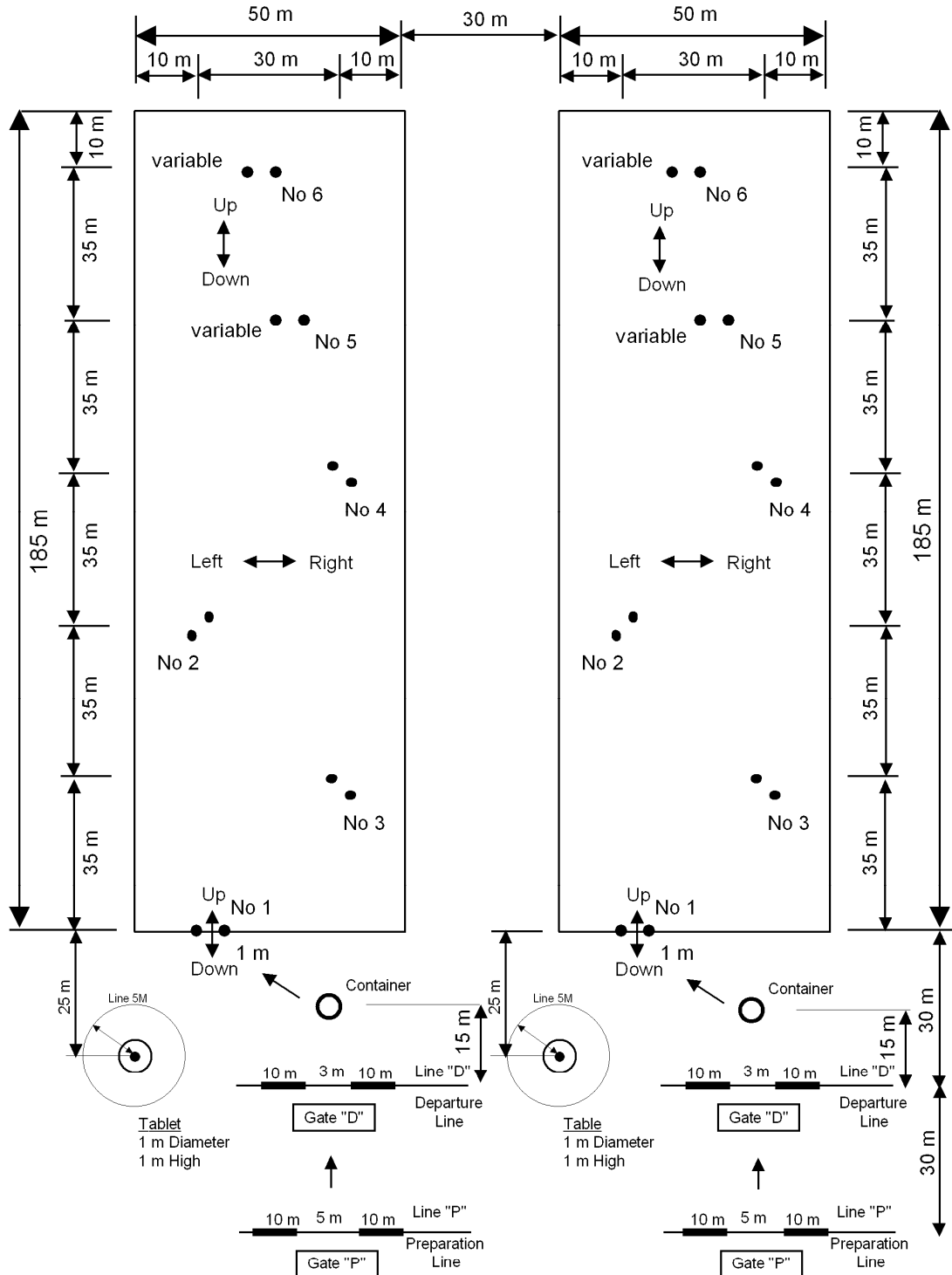

**Annex 2 - Event 5.4 Poles and Table**  
 NOT TO SCALE

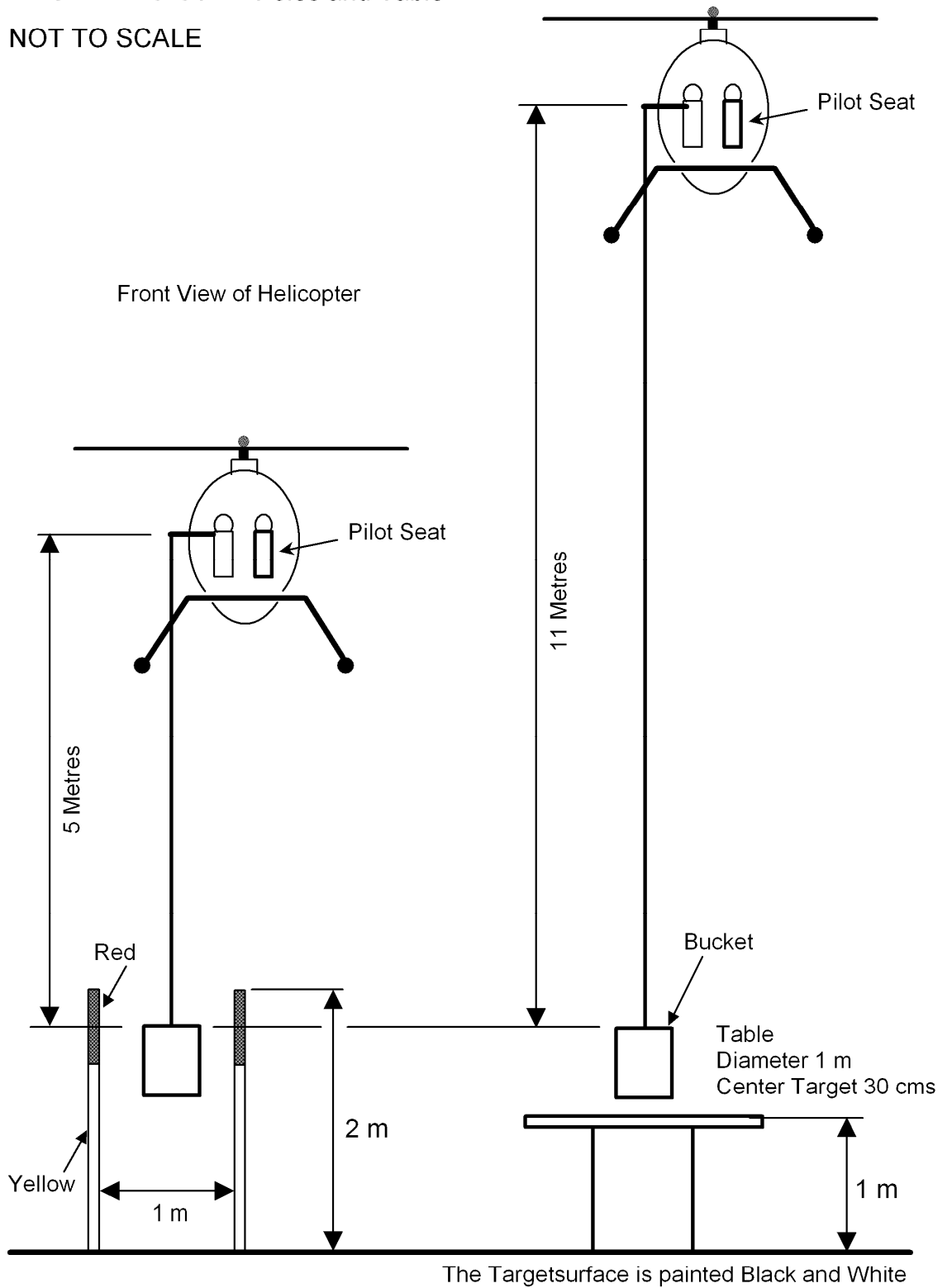

**Annex 3 - Event 5.4 - Rope Equipment and Bucket**

NOT TO SCALE

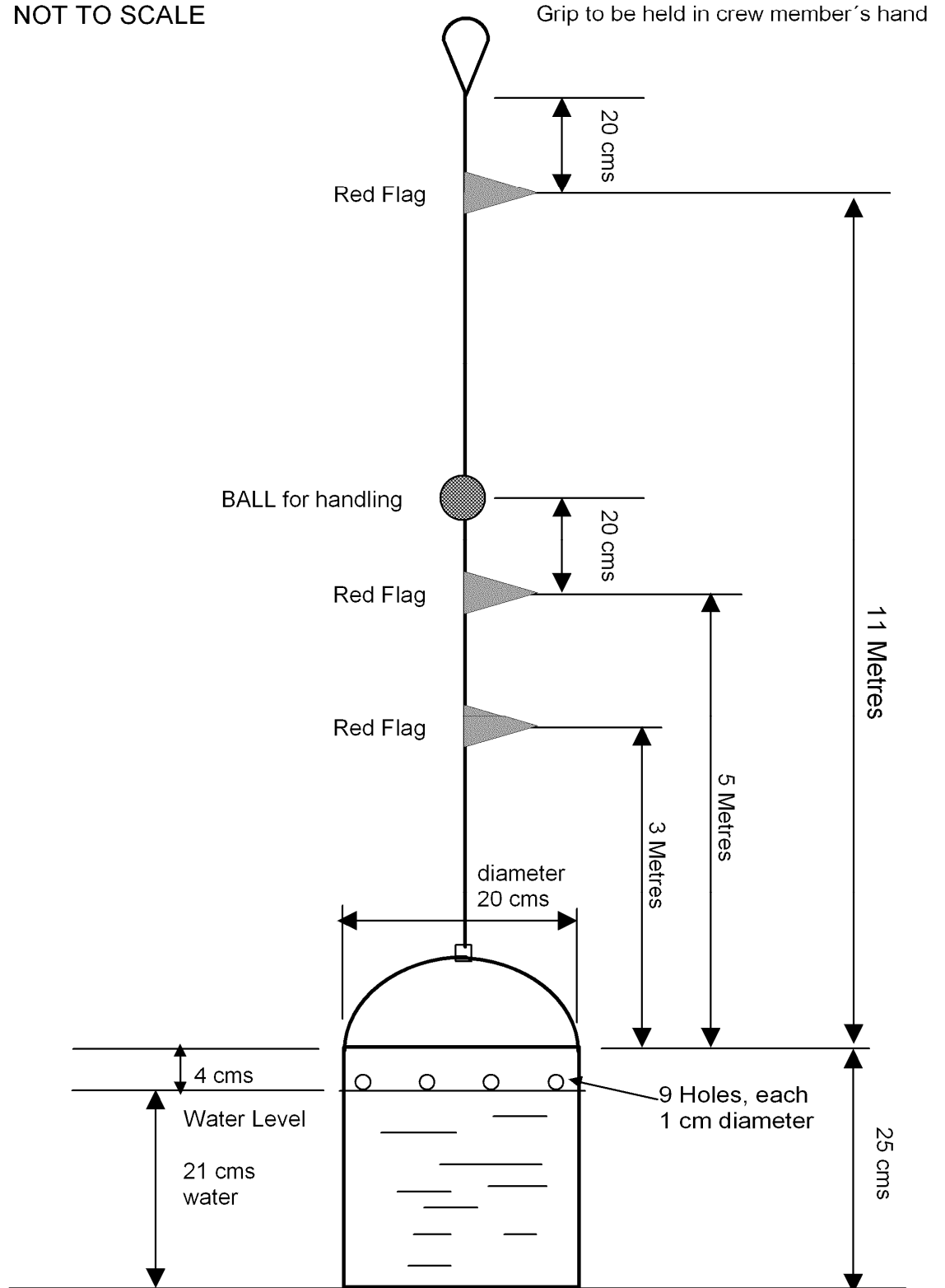

## Event 5.5 - Individual Freestyle

- 5.5.0 The aim of the non-obligatory free style event will be to demonstrate the top level of the helicopter manoeuvrability and to display the highest level of pilots' skill.
- 5.5.1 Any type of helicopter may be used but all proposed manoeuvres will not exceed the helicopter limitations contained in its Flight Manual and in the C. of A. and in no way decrease the level of flight safety.
- 5.5.2 Competitors may make use of smoke and/or music to enhance their display.
- 5.5.3 Competitors will compile and provide a brief and accurate description to their set of manoeuvres to be submitted to the Judging Panel at least 48 hours before the event is scheduled to start.
- 5.5.4 The assessment of proposed manoeuvres will be made by the Judging Panel and the competitor will be informed of possible objections not later than 24 hours before the event starts. Competitors may be required to eliminate or alter any manoeuvre considered as unsafe by the Judges.
- 5.5.5 A briefing will be held prior to the event.
- 5.5.6 Each flight will be a maximum of 4 minutes and not less than 3 minutes 45 seconds.
- 5.5.7 The Freestyle event is open to any pilot or crew who paid the entry fee irrespective of whether they participated in events 1 - 4.
- 5.5.8 The Event will be flown within the display box, which is a defined area of **1000 metres** by **1000 metres** square marked by four edge panels and a centre square and below a height of **300 metres / 1000 feet**/ above ground level.
- 5.5.9 Each edge panel to be 5 metre long and 1 metre wide. The centre square with 5 metre sides.
- 5.5.10 Judges will be placed at each corner to record infringements of the display box. Two Judges will be available for timing purposes.
- 5.5.11 The Competitor may start, on the ground, anywhere within the display box.
- 5.5.12 Timing will commence from lift-off.
- 5.5.13 The competitor will finish, on the ground, in the centre square at the conclusion of his 4 minute program. Timing will finish at touch down of the helicopter in accordance with the submitted briefing.
- 5.5.14 Skilled Judges will be selected by the Chief Judge from the Panel of Judges and can include FAI CIG Delegates, but exclude Jury members.

**SCORING\* - EVENT No. 5 (INDIVIDUAL FREESTYLE)**

Degree of Program difficulty	0-70
Flying technique / skill	0-70
General Impressions	0-60
Infringement of box edge. Penalty/ each violation	20
Flight above audience	DQ
For the duration of performance longer than 4 minutes / 240 seconds/ or shorter than 3 minutes, 45 seconds / 225 seconds/ --- Each second over or under penalty	1

\*The highest and lowest scores will be eliminated. Of the remaining scores the arithmetic mean will be calculated, from which the penalty points will be subtracted.

## **World and Continental Helicopter Championships**

### **Chapter 6 Additional Events**

#### **Event 6.1 FAI World Air Games**

#### **Rules and Regulations for Helicopters**

### **Table of Contents**

#### **Chapter 1**

#### **General Rules and Regulations**

1. Definition of classes and types of helicopters participating
2. Minimum and maximum of competitors and level of experience required
3. Method of selection
4. Documents required for athletes, aircrafts and equipment
5. Composition of panel of judges and jury
6. Competition tasks, scoring and elimination of athletes
7. Complaints and protests

#### **Chapter 2**

#### **Event Rules**

1. Parallel Slalom - rules, scoring and penalties
2. Parallel Fender Rigging - rules, scoring and penalties



## Chapter 1

### General Rules and Regulations

#### 1. Types of helicopters and classes

There is no differentiation into classes. Helicopters of any type with sufficient characteristics to execute the World Air Games Events will be allowed to compete. A crew consists of 2 persons.

#### 2. Minimum and maximum of competitors and level of experience

There should be a minimum of 8 crews and a maximum of 16 crews to compete for the title of “World Air Games Helicopter Champion”. The crews should have been placed in the upper third at the last 2 Helicopter World Championships and/or 3 National Championships.

#### 3. Method of selection

Each country haven taken part in any of the last 3 World Helicopter Championships or similarly FAI Category 2 Events has the right to submit 3 crews and 2 judges to the CIG Bureau for selection.

The nomination of crews must be approved by the respective NAC.

The selection process will be carried out during special CIG Bureau Meeting.

#### 4. Documents required for athletes and helicopters, equipment

Pilots must be in the possession of a valid Pilots Licence complete with Medical Certificate and a FAI Sporting Licence.

For every competing helicopter must be produced to the LOC a valid “Certificate of Airworthiness” or equivalent document and a Certificate of Registration issued by an appropriate authority.

Each competing helicopter must comply with its own National Flight Regulations and must be equipped with a VHF radio and normal standard equipment.

#### 5. Composition of panel of judges and jury

The International Board of Judges consists of 10 FAI – CIG International Judges – including a Chief Judge – and additional Assistant Judges appointed by the LOC. The jury is represented by one person only and will be appointed by CIG Bureau.

#### 6. Competition tasks, scoring and elimination of crews

Helicopter events will be organized as a qualifying contest.

All competitors will be required to perform the events Parallel Slalom and Parallel Fender Rigging at each stage of the competition.

Scoring is determined by subtracting penalty points from 300 as laid down in the infringement lists of each event.

The contest starts with a qualification ( preliminary heat ). All participating crews will be randomly combined into pairs for executing the both parallel events.

After the qualification heats the best 8 crews, having the highest sum of points ( both events added up) will be qualified for the further competition.

For the quarter finals these 8 crews will be combined into 4 pairs as follows:

The crew placed first with the crew placed 5<sup>th</sup> , down to the crew placed 4<sup>th</sup> with the crew placed 8<sup>th</sup>.

The 4 crews having highest sum of points (added up both events) out of quarter finals are qualified for the semi-final.

The crews will be combined into pairs as follows: the crew placed first with the crew placed 4<sup>th</sup> and the crew placed 2<sup>nd</sup> with the 3<sup>rd</sup>.

The two crews having highest sum of points from semi-final heats will contest for the title of World Air Games Helicopter Champion in the final heats.

The Champion is determined by the highest number of points obtained in both events of the final.

## **7. Complaints and protests**

Complaints or protests are only possible against an issue which effects the competitor himself and have no effect to the course of the competition.

Complaints or protests which effect results must be forwarded by the Head of National Delegation ( Point 3.1 General Rules FAI World Air Games) to the Chief Judge within 30 minutes after publication.

## Chapter 2

### World Air Games Events

#### Event 6.1.1 - Parallel Slalom

1. This event is identical with Parallel Slalom event as described in Chapter 5 Event 5.4 with the exception of scoring.

2. **SCORING - EVENT NO. 6.1.1 (PARALLEL SLALOM)**

INFRINGEMENT	PENALTY POINTS
Departure before starting signal is given	20
Passing a gate in the wrong order or different direction	20
Failing a gate by missing or bucket over poles	20
Each tenth of a second in excess of 90 seconds *	0.1
Placing the bucket outside the 30 cm target on table	20
Placing the bucket outside the 60 cm target on table	80
Losing the bucket during the course	300
Rope not deployed before the 5 metre circle around the table	20
Crew not staying seated or fastened ( both hands and legs not visible)	80
Rope shortened, has knots or handled below red flag ( per infringement )	80

\* Black flag if total time exceeds 4 minutes.

#### Event 6.1.2 – Parallel Fender Rigging

1. This event is identical with Parallel Fender Rigging event as described in Chapter 5 Event 5.3 with the exception of scoring

2. **Scoring Event No. 2.2 ( Parallel Fender Rigging )**

Infringement	Penalty points
Departure before starting signal is given	20
For each tenth of a second flown over total times limits	0.1 *
Touching the ground with the fender between D- Line and containers:	
For each touch:	20
Each fender not dropped into the container or lost en route	80
Crew not staying seated or harnessed:	80
Rope shortened, or has knots, or handled below the ball ( for each infringement )	80
Rope not deployed to full metres or has knots when flying over the D-Line or lifting off from containers ( for each infringement )	20
Overfly of the exit gate – helicopter nose is not first part of helicopter to pass the marked gate or the helicopter does not pass the gate at all for each infringement:	20
Fender not passing the Gate “D”	20
Missing the Entrance-Gate by missing or fender over poles ( for each infringement )	20
black flag if total time exceeds 3 minutes	

## **Event 6.2**

### **CIG – ONLINE COMPETITION**

#### INTRODUCTION

In 2011 CIG approved the concept of an inter crew competition using the internet, to encourage helicopter crews to issue challenges across the world with each crew participating in their own country but on an agreed date.

#### HOW TO PARTICIPATE

A crew (pilot and single bucket operator) can issue a challenge by internet or direct email to another crew outside the challenger's country.

If the challenge is accepted the crews must agree on a date for the challenge to take place.

The challenge must be observed and ratified by an independent expert on FAI CIG International Judge.

The full details plus photographic evidence will be sent by each crew to FAI-CIG-Official Judge and to the crew challenged.

The Judge having approved the results will ensure that they are published on the FAI CIG Webpage. He may request further evidence.

There is no limit in the number of challenges that a crew can make in the course of a calendar year.

AWARD :At the end of the year FAI CIG will decide on the overall winner. An annual trophy will be presented.



# CIG Competition

---

*Fédération  
Aéronautique  
Internationale*

## **Helicopter Pen Challenge**

### **Rules and Information**

#### **2010 Edition**

Approved by the I FAI Rotorcraft ii Commission I (CIG)

In February 2010

*Maison du Sport International  
Av. de Rhodanie 54  
CH-1007 Lausanne  
(Switzerland)  
Tél. +41 (0)21 345 10 70  
Fax +41 (0)21 345 10 77  
E-mail: [sec@fai.org](mailto:sec@fai.org)  
Web: [www.fai.org](http://www.fai.org)*

## **FAI on-line helicopter competition**

### **Event 1 - Helicopter Pen**

#### 1.1.0 Event description

The event requires precise flying to manoeuvre a bucket, attached to a 5 metre rope through 3 gates and a "pen". The helicopter will be configured with the pilot's door on & closed, dual controls and crewman's door removed.

Flying times:

- 120 seconds (2 minutes).

#### 1.1.1 Preparation:

The helicopter will come to the preparation line and wait for the previous helicopter to finish.

At a signal from the judges, the helicopter will move and land at the departure line. The loader will hand over the rope with the attached bucket.

The rope will be held by the crew member, sitting on a seat on the side opposite to the pilot, in a normal position and wearing the safety harness correctly. The crew must remain seated. The rope will be maintained on the floor of the cabin, either inside or outside the skids where fitted.

#### 1.1.2 Start:

Upon an indication of ready from the pilot (or crewmember), the starter will signal the start by dropping a flag. The helicopter will take off from the departure line with the bucket resting on the ground, the crewmember holding the rope by the handle. The rope will remain held by the crew member who must have both hands visible. Manoeuvring of the rope is allowed provided the rope is not shortened by any part of the body below the red painted ball.

#### 1.1.3 Composition of the course:

The course comprises of a departure gate, an entrance gate, a pen and an exit gate.

The course will be placed as per **Annex 1**; the direction of flight will be indicated in **Annex 1**.

To correctly pass the entrance gate, the top of the bucket must pass below the top of the poles. If an attempt of passing the gate fails, the bucket must go backwards around the outside of the poles before another attempt is made. Multiple opportunities to pass a correctly will be allowed.

The course will be flown in the following order – departure gate to entrance gate to exit gate via the pen.

#### 1.1.4 Pen and Exit Gate

After passing the entrance gate, the bucket will be lowered into the pen and 4 tasks will be performed:

1. 360° turn of the aircraft to the left ( minimum 15 seconds)
2. Lifting the bucket clear of the pen on completion of task 1
3. Lowering the bucket into the pen
4. 360° turn of the aircraft to the right (minimum 15 seconds).

Each turn must take a minimum of 15 seconds

For the purpose of timing, the timing will start at the beginning of the turn and it will be timed from when the top of the bucket is first lowered into the top of the pen.

To complete the course, the bucket must pass through the exit

#### gate. 1.1.5 Timing

The competition time starts with lowering of a flag by the starter at the departure line and the time stops when the bucket passes the exit gate.

#### 1.1.6 Tie Break

If there is a tie for a place, the winning crew is determined by the shortest flight time with the lowest penalties.

#### 1.1.7 Scoring

Score is determined by subtracting the Penalty Points from 300. The minimum score achievable is zero. Scores will be posted on the FAI CIG website.

#### 1.1.8 Awards

Annually the winner of the event will be awarded a trophy.

#### 1.1.9 Fees

25 CHF per scored entry per crew.

#### 1.1.10 Competitor requirements.

Crews are to hold valid FAI sporting licences.

### 1.1.11 Challenge organisation & frequency.

All challenges have to be witnessed and scored by an International Judge or NAC CIG representative.

Organisers can hold an unlimited number of challenge events in a calendar year.

The number of scored attempts a crew can make at a challenge event in the same day is 3.

### Measurements of competition area and equipment (see attached Annexes)

- 50 x 50 metres competition area. **See Annex 1.**
- One departure, gate internal width 3 metres.
- One entrance, gate internal width 1 metre.
- One pen, dimensions 1.75 metre x 1.75 metre x 1.15 metre high. **See Annex 2.**
- One exit gate, internal width 5 metres
- One 5 litre bucket full of water made from break proof material complete with handling aids. **See Annex 3.**

### **Penalties**

<b>Infringement</b>	<b>Penalty points</b>
Departure before starting signal is given	<b>20</b>
Missing a gate	<b>20</b>
Each second in excess of 120 seconds	1
*Missed pen	<b>100</b>
<b><i>In the pen</i></b>	
Bucket or rope in contact with tape, per second	<b>10</b>
Grounding the bucket, per second	<b>10</b>
Lifting the top of the bucket above the top of the tape, per second	5
Rope shortened, has knots or handled below red ball (per each infringement)	<b>50</b>
Turn completed in less than 15 seconds	<b>15</b>
Bottom of bucket not clear of pen between turns	<b>30</b>
Crew not staying seated or fastened (both hands and legs not visible)	<b>50</b>

*\*the pen will be deemed as missed if the bucket is grounded, lifted above the tape for more than 180 degrees of a turn.*



Annex 1

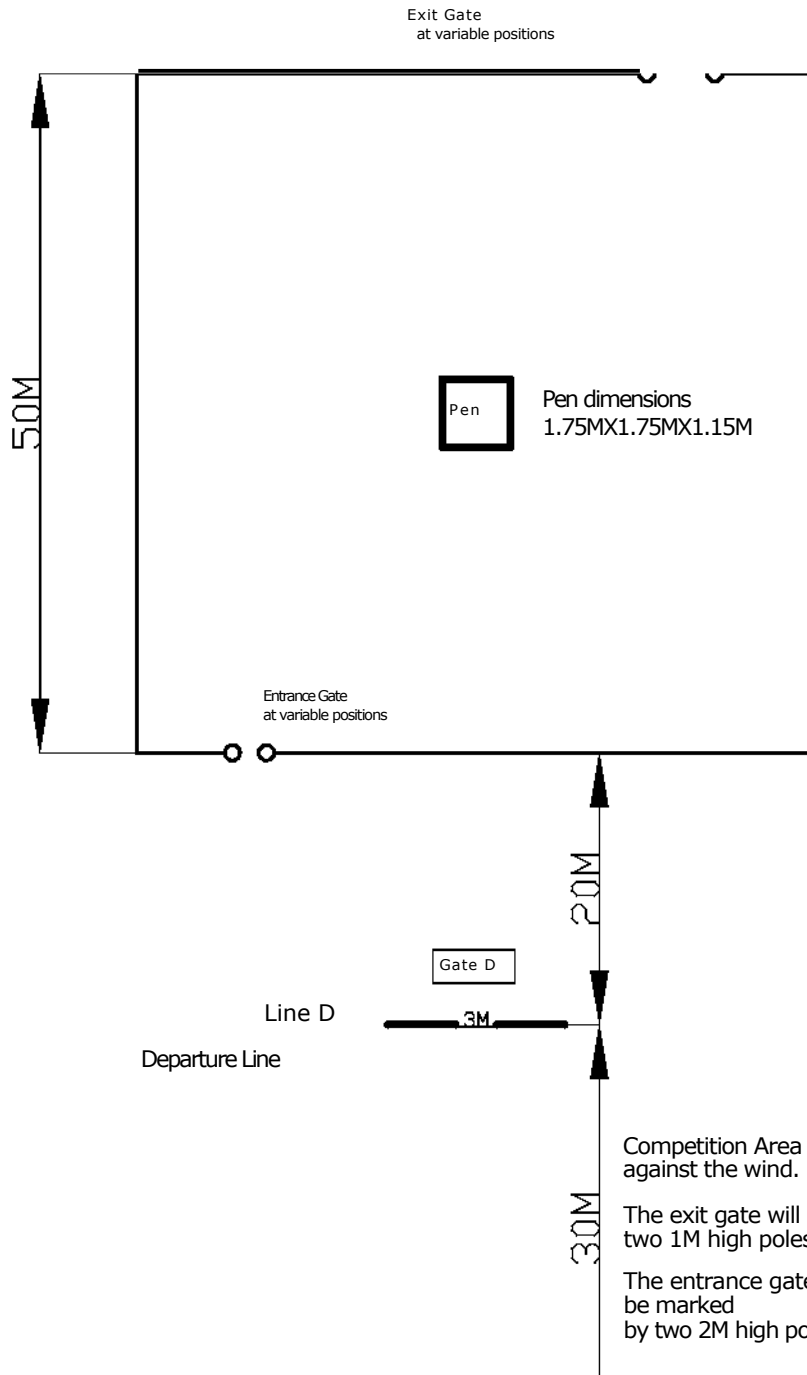

Line P  
Preparation Line

Gate P

# Annex 2

All Dimensions in mm.

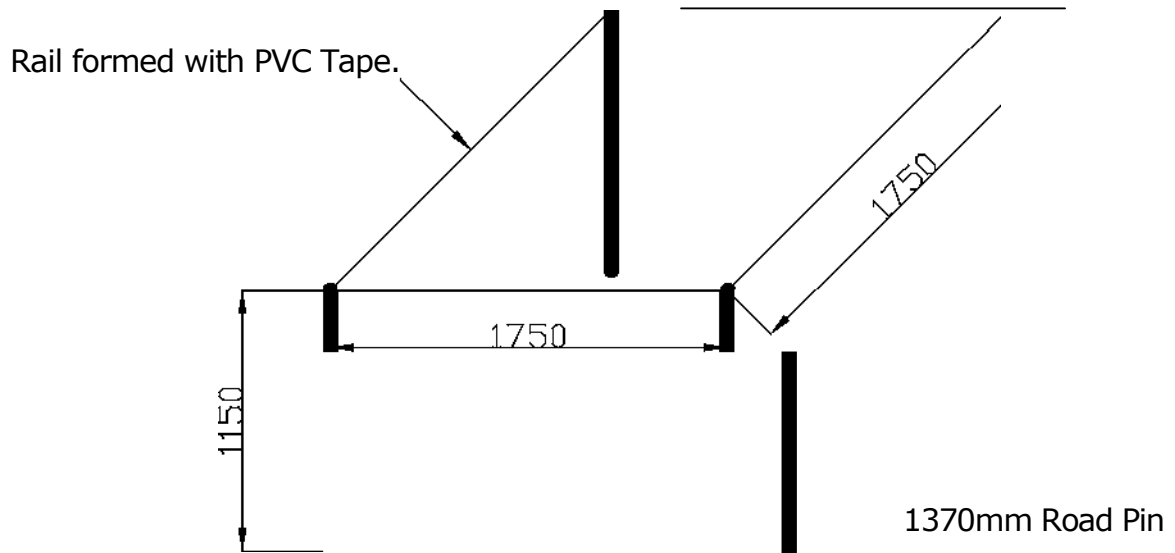

### Annex 3

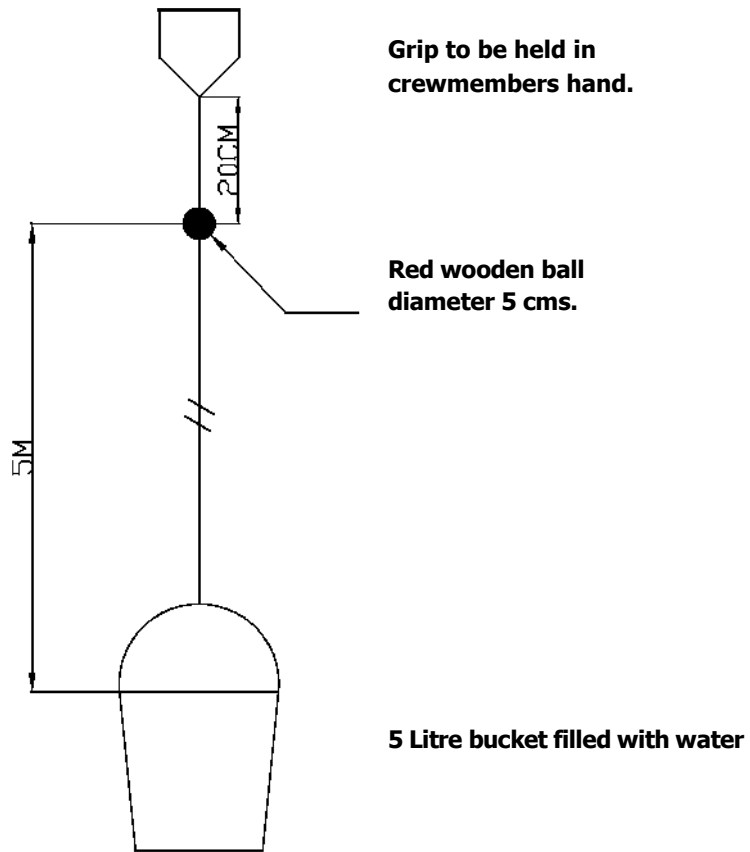

Judge.....

PEN PAL TOTAL TIME ALLOWED 120 SECONDS

Running Order	AIRCRAFT REGN & TYPE	Departure before starting signal is given (X for penalty)	Failing to pass through Entrance Gate (X for penalty)	Failing to pass through Exit Gate (X for penalty)	TOTAL GATE PENALTIES	Bucket or rope in contact with tape, per second (Number of seconds)	Grounding the bucket, per second (Number of seconds)	Lifting the top of the bucket above the top of the tape, per second (Number of seconds)	Turn completed in less than 15 seconds (X for Penalty)	Bottom of bucket not clear of pen between runs (X for Penalty)	Missed Pen (X for	TOTAL PEN PENALTIES	Crew not staying seated or fastened (both hands and legs not visible) (X for Penalty)	Rope shortened, has knots or handled below red ball (per each infringement) (X for penalty)	TOTAL TIME PENALTIES Each second over 120	TOTAL PENALTIES
		20 points	20 points	20 points	Total Points	10 per second	10 per second	5 per second	15 points	30 points	100 points	Total Points	50 points	50 points	1 per second	Total.
1																
2																
3																
4																
5																
6																
7																
8																
9																
10																
11																
12																
13																
14																
15																
16																



**FAI ROTORCRAFT COMMISSION (CIG)**

**HELICOPTER PEN CHALLENGE**

CREW ENTRY FORM

**1. Pilot Name and Title** .....

FAI. Licence Number .....

Nationality .....

**2. Crewmember Name and Title** .....

FAI. Licence Number .....

Nationality .....

**3. Name of National Aero Club** .....

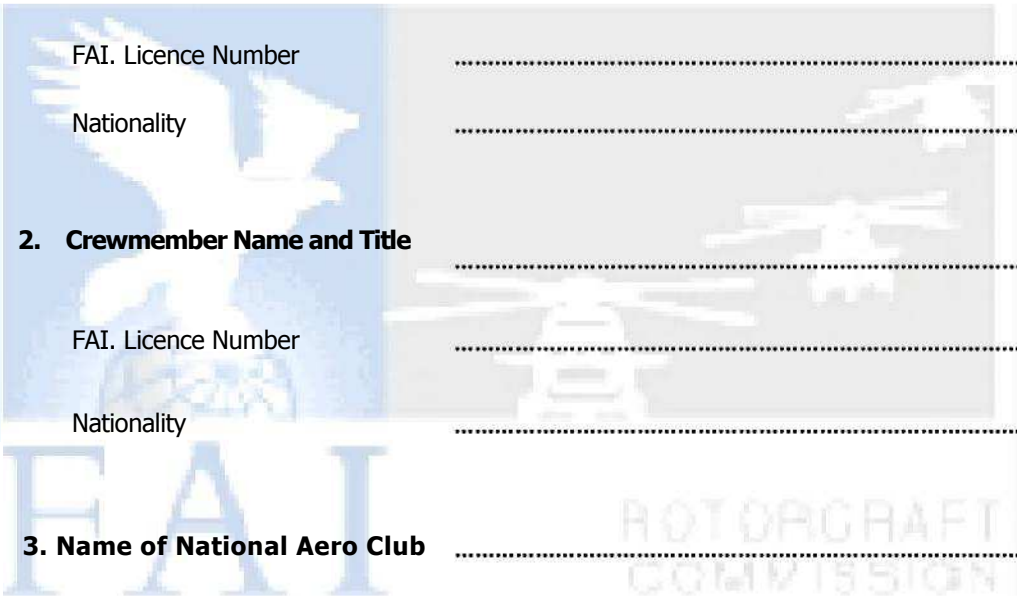

**4. Contact email address** .....

**5. Location of event** .....

**6. Proposed date of event** .....

*Entrance fees: to be paid to FAI-CIG 25 CHF per crew to be paid in advance.*

## World and Continental Helicopter Championships

### Chapter 7 Trophies and Awards

#### 7.0 General

All medals, diplomas and prizes shall be presented at the official prizegiving. Diplomas and prizes for event-winners shall be presented not later than at the event following day.

#### 7.1 Individuals Overall

The crew with the highest overall score will become “Overall World or Continental Champions“.

The members of the crews placed first, second and third will be awarded gold, silver and bronze FAI medals. The crews placed first to 10<sup>th</sup> will be awarded with FAI diplomas. Additional prizes should be awarded at the Organizer’s discretion.

#### 7.2 Teams

The team with the highest overall score will be called “World or Continental Team Champions“.

The team managers of the teams placed first, second and third will be awarded gold, silver and bronze FAI medals. Smaller FAI medals are to be awarded to all members of the teams. All members of the teams placed first, second and third will be awarded FAI Diplomas. Additional prizes can be awarded at the Organizer’s discretion.

#### 7.3 Event Winners

Each crew winning an Event will also be awarded an FAI Diploma and called “Navex Champions “, “Precision Champions “, “Fender Rigging Champions” or “Slalom Champions “.

Additional prizes can be awarded at the Organizer’s discretion to the crews placed first, second or third in each event.

#### 7.4 Females

There will be an award for the all-female crew with the highest overall score and called “Overall World or Continental Ladies Champions“.

The members of the all-female crews placed first, second and third will be awarded gold, silver and bronze FAI medals. The female crews placed first to 5<sup>th</sup> will be awarded FAI diplomas.

Additional prizes can be awarded at the Organizer’s discretion.

#### 7.5 Freestyle

There will be an award for the Pilot with the highest Freestyle score called “Freestyle Champion “.

The pilots placed first, second and third will be awarded FAI diplomas and Organizer’s prizes.

#### 7.6 Novice Pilots

The pilots placed first, second and third in the junior category will be awarded FAI diplomas and additional prizes at the Organizer’s discretion.

**ANNEX A****HELICOPTER TYPE AND COMPETITION SPEED**

<b>HELICOPTER TYPE</b>	<b>COMPETITION SPEED ( KTS )</b>	<b>COMPETITION SPEED ( KPH )</b>	<b>CRUISE SPEED ( KTS )</b>
Robinson R22 – HP	64	118	80
Robinson R22 – Alpha	64	118	80
Robinson R22 – Beta	64	118	80
Robinson R22 – Mariner	56	104	70
Robinson R22 – Astro	77	143	96
Robinson R 44-Astro	80	148	100
Robinson R 44-Raven I	80	148	100
Robinson R 44-Raven II	90	166	117
Robinson R 66	90	166	125
Bell 47	56	104	70
Bell 205 (UN-1H)	80	148	100
Bell 206 I Jet Ranger	80	148	100
Bell 206 II Jet Ranger	80	148	100
Bell III Jet Ranger	80	148	100
Bell 206 Long Ranger	80	148	100
Bell 212	80	148	100
Bell 214	90	166	115
Hughes 300A	60	111	75
Hughes 300B	60	111	75
Hughes 300C	60	111	75
Schweizer 300	60	111	75
Schweizer 300CB	56	104	70
Schweizer 330	72	133	90
Hughes 500HS	80	148	100
Hughes 500C	80	148	100
Hughes 500D or MDHC 500D	90	166	120
Hughes 500 or MDHC 500E or F	90	166	120
Hughes 500 or MDHC 530N or F	90	166	120
Aerospatiale Gazelle	90	166	140
Aerospatiale Ecureuil or ASTAR AS350B	90	166	115
Aerospatiale Ecureuil or ASTAR AS350B2	90	166	120
Aerospatiale Dauphin (HH-65)	90	166	140
Mil Mi – 2	72	133	90
Enstrom F28A	56	104	70
Enstrom F28C or F	64	118	80
Enstrom F280C	64	118	80
Enstrom 280 FX	72	133	90
Alouette II	64	118	80
Alouette III	72	133	90
Eurocopter EC 120	90	166	122
BO 105	90	166	120
Cabri	64	118	80

Helicopter competition speed will be 80% of the maximum safe sustainable cruise speed in straight and level flight with two average weight persons and 1.5 hours fuel on board.

The maximum competition speed will be 90 kts (166 kph)

## **ANNEX B**

### **Measuring Equipment**

#### **B-1. GENERAL :**

As stipulated in 12.6 and 12.7 of Chapter 2, all measuring equipment must be submitted to the FAI - CIG for approval prior to the Championship.

The judgments in the competition that may require the use of equipment are listed below. In some cases such as time-keeping, the use of equipment, in this case a clock or watch, is mandatory.

In other cases such as calculating speed, height or distance, the organizer may use technical equipment in addition to the judgment of the judges.

If equipment is being used for a particular measurement, it must be described in full to the FAI - CIG in accordance with Chapter 2 para 12.6, or, the organizer must state that no equipment will be used.

In this case measurement will be taken by the skill and judgment of the judges.

#### **B-2. Navigation**

##### **Mandatory Equipment**

Master Clock, Start Line Clock, Search Box Exit Clock, Gate A Clock.

The Organizer must demonstrate that the timepieces are of sufficient quality and that they can be synchronized to the Master Clock to an accuracy of 0.01 seconds. GPS-based Data Loggers for measurement of the track, times and speed on the course. Loggers will be provided by the Organizer.

##### **Optional Equipment**

For measurement of height at targets in the dropping zone and at Line A and F.

For measurement of speed and 30 degree variation on final leg.

To avoid potential complaints and protests, the organiser should ensure that there is some clear indication of the last 2 km to the judges.

TP1 Clock, TP2 Clock, TP3 Clock

#### **B-3. Events 2, 3 and 4**

No special equipment required.



**ANNEX C  
Judge`s Qualification Declaration**

**FAI-CIG JUDGES INFORMATION**

Name ( in full ).....

NAC.....

International Judge (since).....Assistant Judge (since).....

Year	National Competition or Category 2 Event Status	World Championship Status
------	--	------------------------------

2008

2009

2010

2011

2012

2013

2014

Attendance at National Judges Training: 2009 2010 2011 2012 2013 2014

Identity and qualification of trainer:

**I confirm that the above represents the active experience in judging of helicopter events run in accordance with the relevant FAI-CIG World and Continental Championship Rules**

Signature of Judge:

Certified that the above is correct:

( Representative of National Aeroclub )